



PORTABLE SOLAR POWER SYSTEM

USER MANUAL



LD150S-N1/N1R
LD150S-N2/N2R
LD150S-N3/N3S
LD150S-N4/N4R

Contents

Important Safety Instructions	1
1. Product Overview.....	2
2. System composition	3
3. Name definition	4
4. Classification.....	4
5. Portable solar power supply.....	6
5.1 LD150S-N1/N1R.....	6
5.2 LD150S-N2/N2R.....	6
5.3 LD150S-N3/N3S	7
5.4 LD150S-N4/N4R.....	8
5.5 Radio instruction	10
6. PV array requirement.....	12
7. Lithium battery configuration	12
7.1 Attention of using the lithium battery	12
7.2 Lithium battery requirement	12
7.3Lithium battery parameters	12
7.4 Lithium battery control voltage parameters	13
8. Utility charge function.....	13
9. Operation instruction	14
9.1 LD150S-N1/N1R operation instruction.....	14
9.2 LD150S-N2/N2R operation instruction.....	14
9.3 LD150S-N3/N3S operation instruction	15
9.4 LD150S-N4/N4R operation instruction.....	15

10. Protection	16
10.1 LD150S- N1/N1R/N2/N2R/N4/N4R/N4S protection	16
10.2 LD150S- N3/N3S protection.....	16
11. Troubleshooting	17
11.1 LD150S-N1/N1R/N2/N2R troubleshooting.....	17
11.2 LD150S-N3/N3S troubleshooting.....	18
11.3 LD150S-N4/N4R troubleshooting.....	19
12. Technical Specifications.....	20
13. Disclaimer	22
Annex I Mechanical Dimension Diagram	23

Important Safety Instructions

Please reserve this manual for future review.

This manual contains all the instructions about safety, installation, and operation for the EZPOWER series portable solar power system (hereinafter referred to as the solar system).

- Read all the instructions and warnings carefully before installation.
- No user-serviceable component inside the solar system. DO NOT disassemble or attempt to repair the solar system.
- Do not place the device in humid, greasy, flammable, explosive, dust accumulative or other severe environments.
- Place the device at well-ventilated places, the device may become very hot during working.
- Avoid fire or the high-temperature environment during use.
- Avoid direct sunlight, high temperature and do NOT install the device at locations where water can get in.
- Do NOT use non-compliant parts or electronics.
- Fully charge the Lithium battery for the first time operation,
- Turn off the equipment while not using it on rainy days.
- Fully charge the Lithium battery monthly while not using it for the long term.
- Avoid drop and collision while moving.
- Over-temperature protection rule: when the system detects the Lithium battery is overheated, it will stop charging or discharging until the temperature drops to normal. To avoid over-temperature protection, reduce the power output is recommended.

1. Product Overview

EZPower DC portable system is a functional off-grid power supply for home and business use, which includes LED light, USB port, cigarette lighter, FM radio in rich interface connection to fit the customer demands. It's also an efficient energy solution nowadays.

Features:

- Select the configuration according to your requirements.
- Support different PV panel power 20W-150W and the max. PV open circuit is less than 30V
- Smart dimension, but long life span. It supports LiFePO₄(10~20Ah available) and Li(NiCoMn)O₂(10~38Ah available) battery type
- All models are DC output, especially used for LED light, fans, phone charging, and some other small DC appliance.
- USB 5V 2.1A output, charging mobilephones and other small USB-powered devices
- LED indicators display the system running status
- Low power consumption and industrial design to reduce loss.
- Multiple protection features to ensure system security and reliability.
- Utility charging function, more convenient for power storage.
- Packed with a solar FM radio with MP3 playback to stay up-to-date on important news or listen to music
- Embedded LED light 1W for emergency use
- Cigarette lighter for bigger current output usage
- Lightweight 3-8kgs, users can put anywhere they want

2.System composition

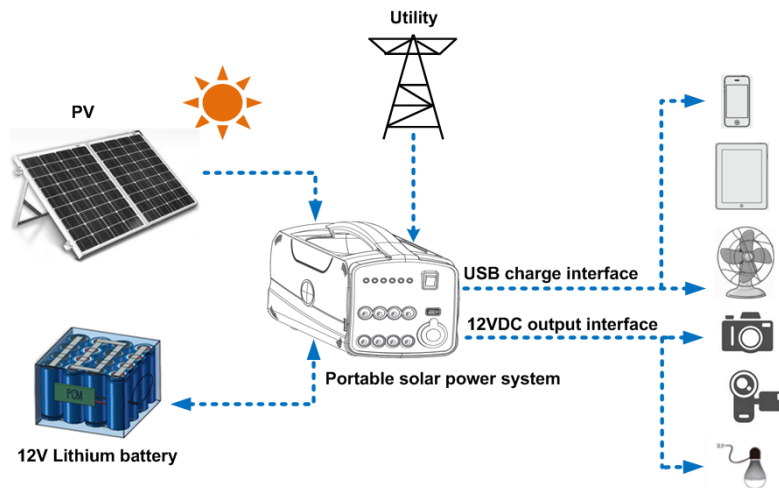

No.	Parts names		Specifications	Note
1	PV array		Max. PV open circuit voltage: $V_{oc} < 30V_{dc}$ PV power: $W < 150W_{p}$ (except $N4 \leq 60W_{p}$) PV array with stent	
2	Portable solar power system	Solar charge controller	Input voltage range: 12Vdc Charge current: 10A except $N4 \leq 5A$	The utility charge module is optional
		Utility charge module	Utility input voltage: 220/230Vac Utility input frequency: 50/60Hz Utility charging current: $3A \pm 0.3A$.	
		Lithium battery	Voltage class: 12Vdc $Li(NiCoMn)O_2$ lithium battery capacity: 10/16/38AH $LiFePO_4$ lithium battery capacity: 12/18AH	
3	LED lamp		1.2W/12V, connection cable with the switch ^① (5m)	Cable length can be customized
4	USB charge cable ^②		All-in-one USB charge cable (1m)	
5	DC output cable ^③		12V/5A output cable (2m length can be customized), Both ends are DC5525 plugs	Optional

① Connection cable with the switch



② USB charge cable

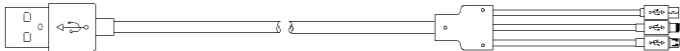

③ DC output cable

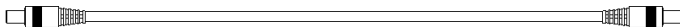

3. Name definition

L D 150 S - N1 S

•S:Utility, R:Rodio

•N1/N2/N3/N4

•Standard

•Max. PV input power150W

•DC input/output

•12V Li-NiCoMn/LiFePO4 optional

4.Classification

Model	Picture	Instruction
LD150S-N1		8-way DC12V3A, max. output is120W 1-wayUSB5V2.1A output 1pcs DC12V10A cigarette lighter
LD150S-N1R		8-wayDC12V3A, max. output is 120W 1-way USB5V2.1A output 1pcs DC12V10A cigarette lighter Silver radio

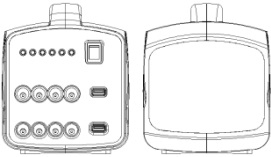
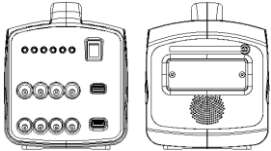
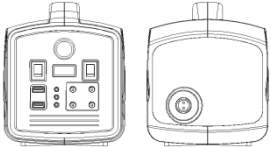
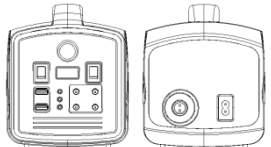
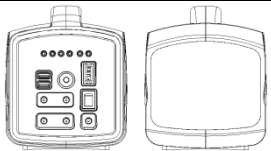
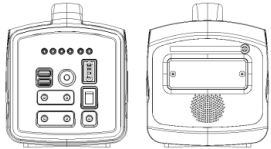
LD150S-N2		<p>8-wayDC12V3A, max. output is 120W 2-wayUSB5V2.1A output</p>
LD150S-N2R		<p>8-wayDC12V3A, max. output is 120W 2-wayUSB5V2.1A output Silver radio</p>
LD150S-N3		<p>4-wayDC12V3A, max. output is 120W 2-wayUSB5V2.1Aoutput 1pcs DC12V1W LED lamp</p>
LD150S-N3S		<p>4-way DC12V3A, max. output is 120W 2-way USB5V2.1Aoutput 1pcs DC12V1W LED lamp 1-way utility input, AC220V,3A± 0.3A</p>
LD150S-N4		<p>4-way DC12V3A(total output current is3A) 2-way USB5V2.1Aoutput</p>
LD150S- N4R		<p>4-way DC12V3A(total output current is 3A) 2-way USB5V2.1Aoutput Silver radio</p>

5. Portable solar power supply

5.1 LD150S-N1/N1R

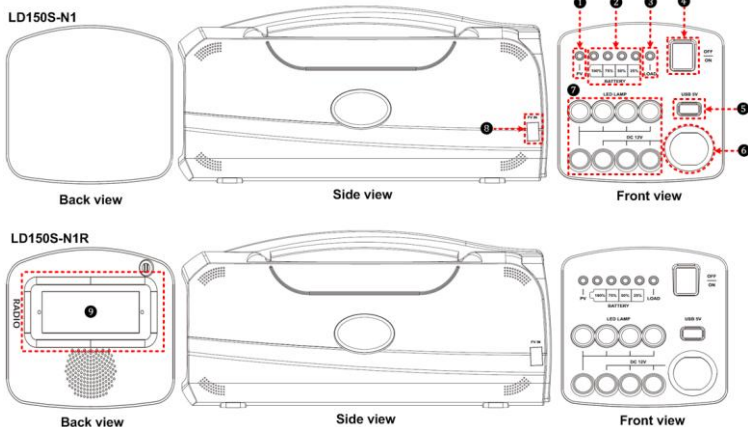

①	PV Charge indicator	⑥	Cigarette lighterport(DC12V/10A)
②	Battery capacity indicator	⑦	8-way DC input(12VDC/3A)
③	Load status indicator	⑧	PV input charge port
④	System switch	⑨	Silver radio with remote control meter
⑤	USB charge interface(5VDC/2.1A)		

5.2 LD150S-N2/N2R

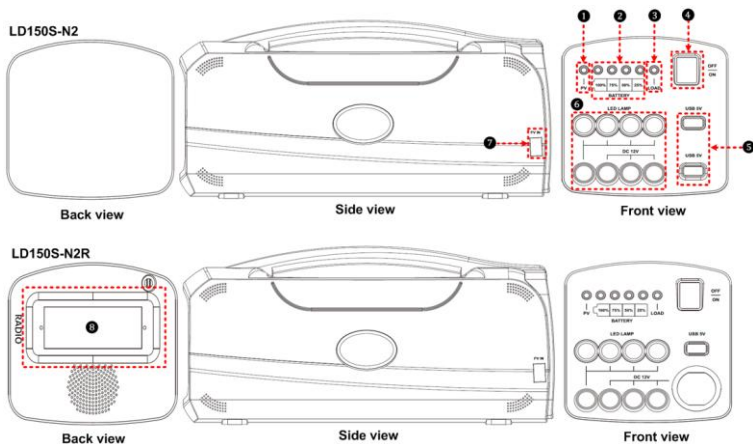



1) Characteristics instruction

①	PV Charge indicator	⑤	2-way USB charge port(5VDC/2.1A)
②	Battery capacity indicator	⑥	8-way DC input port(12VDC/3A)
③	Load status indicator	⑦	PV input charge port
④	System switch	⑧	Silver radio with remote control meter

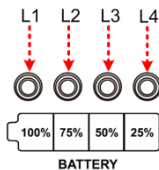
2) Indicator instruction

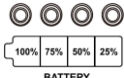

Indicator	Color	Status	Instruction
 PV	Green	OFF	Not connect the PV or no sunlight
	Green	On Solid	Connect the PV
 BATTERY	L1~L4 yellow	All OFF	Not connect the battery
	L1~L4 yellow	On Solid	Battery capacity: from left to right $\leq 25\%$ 、 $25\% \sim 50\%$ 、 $50\% \sim 75\%$ 、 $75\% \sim 100\%$
 LOAD	Red	OFF	Load overload Load short circuit
	Red	On Solid	DC output is normal

5.3 LD150S-N3/N3S

LD150S-N3

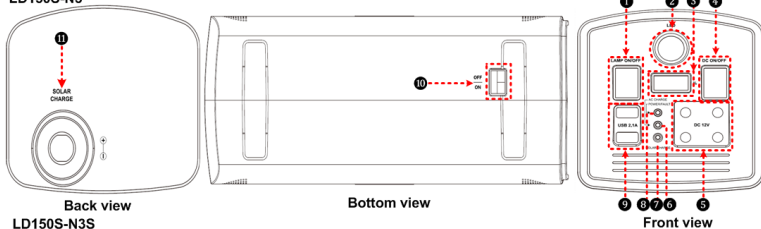

LD150S-N3S

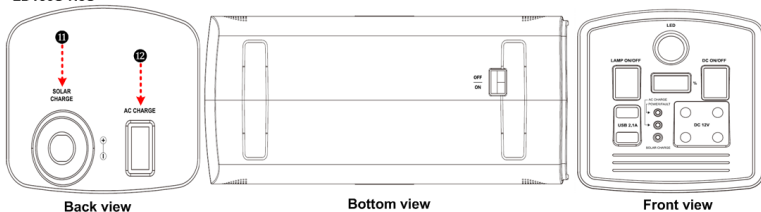

1) Characteristics instruction

①	LED lamp switch	⑦	PV Charge indicator
②	LED lamp(12VDC/1W)	⑧	System Status indicator
③	Nixie tube display battery capacity	⑨	2-way USB charge port (5VDC/2.1A)
④	DC output switch	⑩	System switch
⑤	4-way DC input port(12VDC/3A)	⑪	PV input port
⑥	Utility charge indicator	⑫	Utility input port

2) Indicator instruction

Indicator	Color	Status	Instruction
System Status indicator	Green	OFF	No DC output
	Green	On Solid	DC output is normal
	Red	On Solid	Fault
Utility charge indicator	Green	OFF	No utility
	Green	On Solid	utility is normal
PV Charge indicator	Green	OFF	Not connect the PV or no sunlight
	Green	On Solid	Connect the PV

3) Nixie tube display

	Lithium battery capacity display	1-100 step size 1%	The buzzer sounds when the battery capacity is less than 5% battery capacity.	
	Fault display	E01		Short circuit
		E02		Overload
		E03		Overtemperature
		E04		Overvoltage

5.4 LD150S-N4/N4R

LD150S-N4

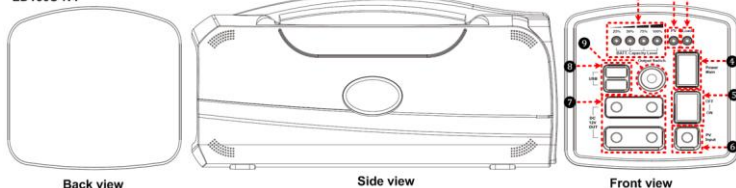

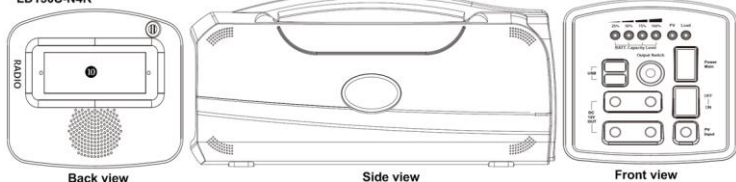

LD150S-N4R



1) Characteristics instruction

①	Battery capacity indicator	⑥	PV input port
②	PV Charge indicator	⑦	4-way DC input port(12VDC/3A)
③	Load status indicator	⑧	2-way USB charge port (5VDC/2.1A)
④	System fuse(10A/32VDC)	⑨	DC output switch
⑤	System switch	⑩	Silver radio with remote control meter

2) PV charge indicator and load indicator instruction

Indicator	Color	Status	Instruction
	Green	On Solid	Connect the PV
	Green	OFF	Not connect the PV or no sunlight
	Green	slowly flashing (1Hz)	In charging
	Green	fast flashing (4Hz)	PV overvoltage
	Green	On Solid	The load output
	Green	OFF	The load no output

3) Battery capacity level indicator instruction

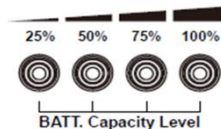

“○” indicator OFF; “●” indicator On Solid; “☆” indicator slowly flashing; “★” indicator fast flashing.

Battery Capacity Level(BCL)

Indicator	Color	Status	Instruction
★○○○	Red	25% indicator fast flashing	Over discharged
☆○○○	Red	25% indicator slowly flashing	0< BCL<25%
●☆○○	Red	50% indicator slowly flashing; 25% indicator On Solid	25%≤BCL<50%
●●☆○	Red	75% indicator slowly flashing; 25%,50% indicator On Solid	50%≤BCL<75%
●●●☆	Red	100% indicator slowly flashing; 25%,50%,75% indicator On Solid	75%≤BCL<100%
●●●●	Red	25%,50%,75%,100% indicator On Solid	100%
★★★★	Red	25%,50%,75%,100% indicator fast flashing	Battery overvoltage
○○○○	OFF	25%,50%,75%,100% indicator OFF	Battery low voltage Battery connection error

4) Button

Output Switch button can control USB and 12VDC port output, the USB and 12VDC port is default ON when the power on.

5.5 Radio instruction

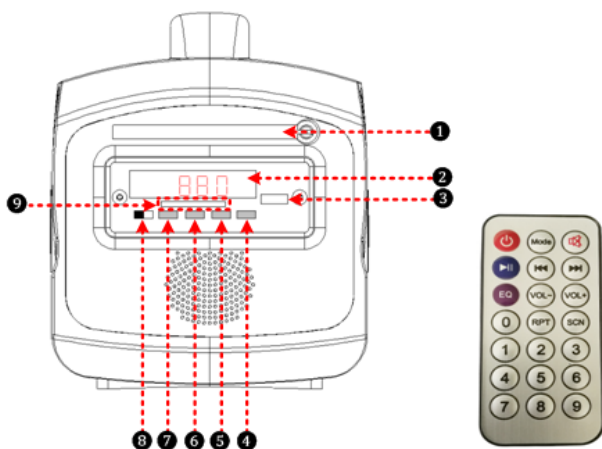

1) Radio function

①	Radio antenna
②	LCD(time and mode display),AUX external audio file playback, FM radio
③	USB/U disk broadcast,U disk support up to 32G
④	MODEmodel
⑤	▶▶/V+ Down/Volume+
⑥	▶▶ Pause
⑦	◀◀/V- Up/Volume-
⑧	OFF/ON power switch
⑨	SD big card slot, up to 32G

2) Radio operation instruction

Step1: Pull-out the radio antenna;

Step2: Power on the radio;

Step3: Press the MODE button;

Step4: Press||◀◀or ▶▶|| button to select the station.

NOTE:

① The radio varies by location and environment, and may not be picked up where the signal is weak.



② Firstly, press the ||◀◀/V- button, secondly, press ▶▶|| button, the radio channel will be searched automatically.

Setting the time via the remote meter



Operation:

Press the  button to display the time status;

Long press the  button, the **hour** of the time is flashing;

















Press the  or  button to change the **hour** of the time;

Press the  button to change the **minute** of the time;

Press the  or  button to change the **minute** of the time;

Press the  button to save the change.

3) The remote meter

 Turn ON/OFF	 UP(press the button) Fast reverse(long press the button)
 Mode(Radio/Music/Line)	 Down(press the button) Fast forward(long press the button)
 Mute button	 Volume-
 Play/Pause	 Volume+
 POP/ROC/CLA/JA2/COU/NOR and so on	
 ~  button When U disk or SDcard broadcast, the number can broadcast the music.	
 "ONE" song cycle; "ALL" all cycle; "LAN" order play, "FOND" random play.	
 Long press the button, the hour is flashing, press the  or  button to set. Press the  button to change the minute setting, the way follow the above. The setting mode exit when waiting for 3s.	

6. PV array requirement

PV array type	Monocrystalline panel Polycrystalline panel
Max. PV Open Circuit Voltage	<30V
PV array power	≤150Wp(N4≤60Wp)

7. Lithium battery configuration

7.1 Attention of using the lithium battery

- Technician required for maintenance and repairing, do NOT disassemble and repair the equipment personally.
- The operation of overload may cause the battery to be damaged or safety accidents.
- Turn off the equipment after use to save battery life and avoid any problem or accident caused by heating during standby mode.
- Fully charge the battery monthly to ensure the life of the battery, if the equipment is not used in the long term,
- The equipment should be stored in a cool, dry, and ventilated room, also away from direct sunlight, inflammable, and explosives.
- Keep the equipment away from water, which may cause device failure, short circuit, or safety accidents.
- Do NOT throw lithium batteries into water or fire, which may cause the battery damaged or safety accidents.
- Keep the lithium battery away from children.
- Do NOT disassemble the lithium battery or try to penetrate it with sharp metal objects, which may cause fire or explosion.
- Do NOT throw the wasted battery away randomly, and send it to the battery recycling department.

7.2 Lithium battery requirement

Lithium battery capacity: 10~38AH/12V;

Lithium battery type: Li(NiCoMn)₂O₂ or LiFePO₄ selectable;

Inside lithium battery size: 222mm×120×70mm(L*W*H).

7.3 Lithium battery parameters

Model	Battery type	Battery capacity
LD150S-N1/N1R	Li(NiCoMn) ₂ O ₂	16Ah/38Ah
LD150S-N2/N2R	Li(NiCoMn) ₂ O ₂	10Ah/16Ah
LD150S-N3/N3S	LiFePO ₄	18Ah

LD150S-N4/N4R	LiFePO4	12Ah
---------------	---------	------

7.4 Lithium battery control voltage parameters

control voltage parameters	LiFePO4	Li(NiCoMn)O ₂
Over Voltage Disconnect Voltage	15.6V	12.9V
Over Voltage Reconnect Voltage	14.5V	12V
Equalize Charging Voltage	14.5V	12.3V
Boost Charging Voltage	14.5V	12.3V
Float Charging Voltage	13.8V	11.8V
Boost Voltage Reconnect Voltage	13.2V	12.1V
Low Voltage Reconnect Voltage	12.4V	10.5V
Under Voltage Warning Recover Voltage	12.2V	10.4V
Under Voltage Warning Voltage	12.0V	10V
Low Voltage Disconnect Voltage	11.1V	9.4V
Discharging Limit Voltage	10.8V	9.4V

NOTE: Above parameters are default value, the parameters can be set according to the user's requirement.

8. Utility charge function

Only LD150S-N3S has the utility function, follow the parameter:

Utility input voltage range	176~264VAC
Utility input frequency	50/60Hz
Utility charge current	3A±0.3A

9. Operation instruction

9.1 LD150S-N1/N1R operation instruction

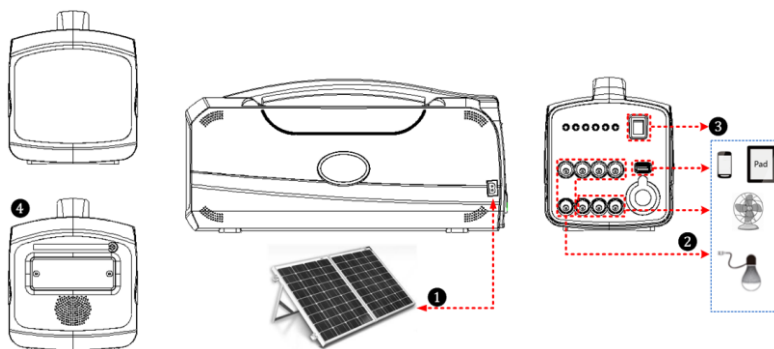

- 1 Connect the PV array;
- 2 Connect the DC load;
- 3 Turn on the system switch, battery capacity level indicator and PV indicator flash once time, after the battery capacity level, PV and load indicator enter the actual status.
- 4 Power on the radio, pull out the antenna to receive the programs; or insert the U disk or SD card to play music.

9.2 LD150S-N2/N2R operation instruction

- 1 Connect the PV array;
- 2 Connect the DC load;
- 3 Turn on the system switch;
- 4 Power on the radio, pull out the antenna to receive the programs; or insert the U disk or SD card to play music.

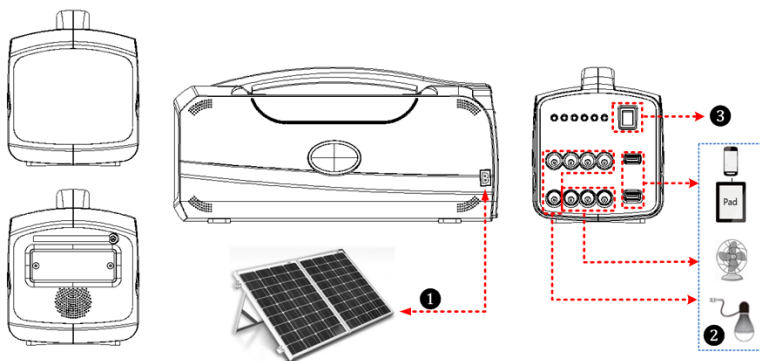

9.3LD150S-N3/N3S operation instruction

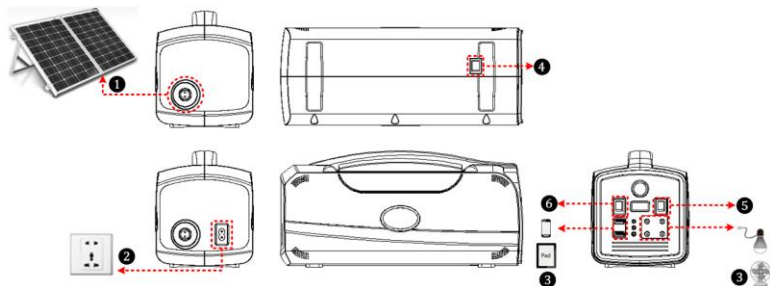

- 1 Connect the PV array;
- 2 Connect the utility;
- 3 Connect the DC load;
- 4 Turn on the system switch;
- 5 Turn on the DC load switch;
- 6 Turn on the lamp switch (according to the requirement).

9.4LD150S-N4/N4R operation instruction

- 1 Connect the PV array;
- 2 Connect the DC load;
- 3 Turn on the system switch;
- 4 Turn on the DC load switch;
- 5 Power on the radio, pull out the antenna to receive the programs; or insert the U disk or SD card to play music.

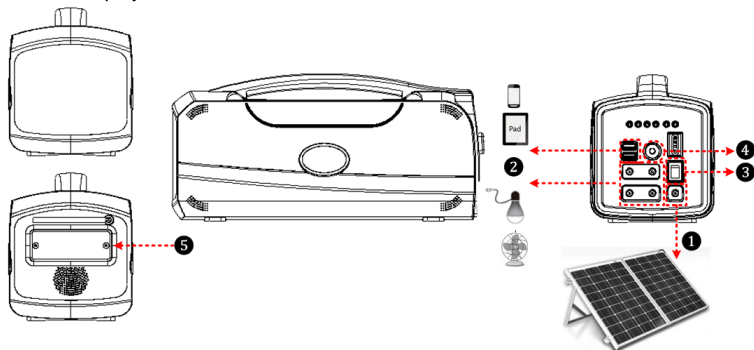

10. Protection

10.1 LD150S-N1/N1R/N2/N2R/N4/N4R/N4S protection

PV Reverse Polarity	When the polarity of the PV array is reversed, the device may not be damaged and can continue to operate normally after the polarity is corrected.
Lithium Battery Reverse Polarity	Fully protected against battery reverse polarity; no damage will occur to the battery. Correct the miswire to resume normal operation.
Lithium Battery Over Voltage	When the battery voltage reaches the overvoltage disconnect voltage(OVD), it will automatically stop battery charging to prevent battery damage caused by over-charging.
Lithium Battery Over Discharge	When the battery voltage reaches the low voltage disconnect voltage, it will automatically stop battery discharging to prevent battery damage caused by over-discharging.
Load Overload	When the overload current is ≥ 1.5 times the rated load current, the device will automatically cut off the output.
Load Short Circuit	When the load is short circuit the device will automatically cut off the output.
High Voltage Transients	The internal circuitry of the device is designed with Transient Voltage Suppressors (TVS) which can only protect against high-voltage surge pulses with less energy. If the controller is to be used in an area with frequent lightning strikes, it is recommended to install an external surge arrester.

10.2 LD150S-N3/N3S protection

Lithium Battery Over Voltage	When the battery voltage reaches the overvoltage disconnect voltage(OVD), it will automatically stop battery charging to prevent battery damage caused by over-charging.
Lithium Battery Over Discharge	When the battery voltage reaches the low voltage disconnect voltage, it will automatically stop battery discharging to prevent battery damage caused by over-discharging.
Lithium Battery Overheating	If the battery temperature is higher than 45°C, the device will stop charging, the restore temperature is 38°C; the temperature is higher than 60°C, the device will stop discharging, the restore temperature is 48°C.
Load Overload	When the overload current is ≥ 1.2 times ($\geq 9.6A$) the rated load current, the device will automatically cut off the output.
Load Short Circuit	When the load is short circuit (≥ 4 times the rated load current,) the device will automatically cut off the output.
High Voltage Transients	The internal circuitry of the device is designed with Transient Voltage Suppressors (TVS) which can only protect against high-voltage surge pulses with less energy. If the controller is to be used in an area with frequent lightning strikes, it is recommended to install an external surge arrester.

11. Troubleshooting

11.1 LD150S-N1/N1R/N2/N2R troubleshooting

Faults	Faults phenomenon	Troubleshooting
System no power	OFF/ON power switch is ON,PV,BATTERY,LOAD indicator OFF	Battery or PV is abnormal. Firstly, check the connection and status of the battery; second, check the connection and status of the PV.Finally, check the ON/OFF switch.
PV no charging	PV indicator OFF, another indicator is normal	The PV isn't connected or PV charge voltage is low. Check the connection of PV, if the PV is changed, make sure "+" and "-"of the PV.
System low voltage warning	BATTERY 25% indicatorslowly flashing, BATTERY 75%,50% indicator OFF,LOAD indicator on solid	If Battery capacity is low, the load will be OFF, please PV charge the battery in time.
Load no output	LOAD indicator OFF, PV and BATTERY indicator on solid, 5V USB,LED LAMP and 12V DC no power	Load overload or short circuit, restart the device after troubleshooting.
	Only 5V USB no power, other indicatorand 12V DC output	USB overload or short circuit, it will recover output after troubleshooting.
	BATTERY 25% indicator slowly flashing (1HZ), BATTERY 75%,50%,LOAD indicator OFF	The load is OFF when the battery low voltage, please charge the battery in time.
Battery overvoltage warning	BATTERY 100% indicator flashing, other indictors is normal	Please disconnect the PV
PV overvoltage warning	PV indicator slowly flashing, BATTERY 100% indicatorfast flashing	
System overvoltage	PV indicatorand BATTERY 100% indicator flashing, LOAD indicator OFF	
Battery is abnormal	PV slowly flashing, BATTERY fast flashing, LOAD indicator on solid thenOFF	The battery is abnormal or the battery not be connected. Please check the connection of the battery.

11.2 LD150S-N3/N3S troubleshooting

Faults	Faults phenomenon	Troubleshooting
System no power	Turn on the system switch and DC load switch, the system isn't working.	Charge the battery
System low voltage	The buzzer rang, Nixie tube display 5/4/3/2/1, POWER/FAULT red on solid	The utility or PV charge the battery
PV no charging	SOLAR CHARGE indicator OFF	The PV isn't connected or PV charge voltage is low. Check the connection of PV, if the PV is changed, make sure "+" and "-" of the PV.
Utility no charging	AC CHARGE indicator OFF	The utility doesn't connect or the PV is disconnecting, please check the connection.
Load no output	Buzzer rang, Nixie tube display 0	If Battery capacity is low, the load will be OFF, please PV or utility charge the battery in time.
	POWER/FAULT indicator green change to red, Nixie tube display "E01"	Load short circuit, restart the device after troubleshooting.
	POWER/FAULT red indicator On Solid, Nixie tube display "E02"	Load overload, restart the device after decreasing the load.
	POWER/FAULT red indicator On Solid, Nixie tube display "E03"	Lithium battery overheating. The load is ON when the temperature of the battery is 48°C; The PV begins to charge when the temperature of the battery is 38°C
	POWER/FAULT red fast flashing, Nixie tube display "E04"	Lithium battery overvoltage. The load is ON when the battery voltage recovers.
PV overvoltage	PV indicator fast flashing	Please disconnect the PV
LED indicator OFF	Turn on the system switch and LAMP ON/OFF switch LED indicator.	Charge the battery
USB no power	Only USB 2.1A port no power	USB overload or short circuit, it

		will recover output after troubleshooting.
--	--	--

11.3 LD150S-N4/N4R troubleshooting

Faults	Faults phenomenon	Troubleshooting
System no power	BATTERY 25~100% indicator OFF	Battery voltage is low, please charge the battery.
PV no charging	PV indicator OFF	PV is not connected or the voltage is low, check connection.
Load no output	LOAD indicator OFF,PV and BATTERY indicator on solid, 5V USB,LED LAMP and 12VDC no power	Troubleshoot the load short circuit or overload, then restart the device.
	Only 5V USB no power, other indicator and 12V DC output	USB overload or short circuit, it will recover output after troubleshooting.
	BATTERY 25% indicator fast flashing, PV on solid or slowly flashing (1HZ),BATTERY 75%,50%,LOAD indicator OFF	Battery overdischarge. The PV charges the battery.
	BATTERY 25% indicator fast flashing, PV, BATTERY 75%,50%,LOAD indicator OFF	
System low voltage warning	BATTERY 25% indicator slowly flashing, BATTERY 75%,50% indicator OFF,LOAD indicator on solid	Battery low voltage. The PV charges the battery.
System over voltage	BATTERY 25%,50%,75%,100% indicator fast flashing	Battery over voltage. Please disconnect the PV
PV overvoltage warning	PV indicator fast flashing(4HZ)	PV overvoltage. Please disconnect the PV
System fuse burn-out	PV is normal, BATTERY 25% indicator fast flashing, PV, load indicator on solid	Change the fuse, powered on the device.
NOTE: LD150S-N4/N4R have the auto-recovery function for five times(the first time delays 5s, the second time delays 10s, the third time delays 15s, the fourth time delays 20s, the fifth time delays 25s)when the load is overload or short circuit. If the fault still exists, the output is OFF. Users can restart the device.		

12. Technical Specifications

Electrical Parameters

Model	LD150S-N1	LD150S- N1R
System rated voltage	12VDC	
Max. PV Open Circuit Voltage	<30V	
PV array power	≤150Wp	
Lithium battery type	Li(NiCoMn)O ₂	
Lithium battery capacity	16/38AH	
Charge way	PWM	
Max. charge current	10A	
DC output	8-way DC12V3A 1-way cigarette lighterDC12V10A Total output power 120W	
USB output port	DC5V/2.1A	
Self-consumption	16mA	
Radio	---	Silver
Weight	About 2.3kg(Inside the 16AH lithium battery) About 5.8kg(Inside the 38AH lithium battery)	

Model	LD150S-N2	LD150S- N2R
System rated voltage	12VDC	
Max. PV Open Circuit Voltage	<30V	
PV array power	≤150Wp	
Lithium battery type	Li(NiCoMn)O ₂	
Lithium battery capacity	10/16AH	
Charge way	PWM	
Max. charge current	10A	
DC output	8-way 12VDC/3A (Total output power 120W)	
USB output port	2-way 5VDC/2.1A	
Self-consumption	16mA	
Radio	---	Silver
Weight	About 2.0kg(Inside the 10AH lithium battery) About 2.2kg(Inside the 16AH lithium battery)	

Model	LD150S-N3	LD150S- N3S
System rated voltage	12VDC	
Max. PV Open Circuit Voltage	<30V	
PV array power	≤150Wp	
Lithium battery type	LiFePO ₄	
Lithium battery capacity	18AH	
Charge way	PWM	
Max. charge current	10A	
DC output	4-way 12VDC/3A (Total output power 120W)	

USB output port	2-way 5VDC/2.1A	
Emergency lamp	LED lamp DC12V/1W	
Self-consumption	24.8mA	
Utility output voltage range	---	176VAC~264VAC
Utility charge current	---	3A±0.3A
Weight	About 3.4kg	About 3.5kg

Model	LD150S-N4	LD150S- N4R
System rated voltage	12VDC	
Max. PV Open Circuit Voltage	<30V	
PV array power	≤60Wp	
Lithium battery type	LiFePO ₄	
Lithium battery capacity	12AH	
Charge way	MPPT	
Max. charge current	5A	
DC output	4-way 12VDC/3A((total output current is 3A))	
USB output port	2-way 5VDC/2.1A	
Self-consumption	10mA	
Radio	---	Silver
Weight	About 2.1kg	About 2.2kg

Environmental Parameters

Working environment temperature	-10℃~+35℃
Storage temperature range	0℃~+35℃
Relative humidity	≤95%(N.C.)
Enclosure	IP30

Mechanical Parameters

Inside lithium battery dimension	222×120×70mm(H x W x L)
Device dimension	360.3×141.4×167mm(H x W x L)

13. Disclaimer

The warranty does not apply under the following conditions:

- Damage caused by improper use or use of an inappropriate environment.
- Battery voltage/current/power exceeds the input voltage limit of the device.
- Damage caused by the working environment temperature exceeds the rated range.
- Unauthorized dismantling or attempted repair.
- Damage occurred during transportation or handling.
- Damage caused by force majeure.

Annex I Mechanical Dimension Diagram

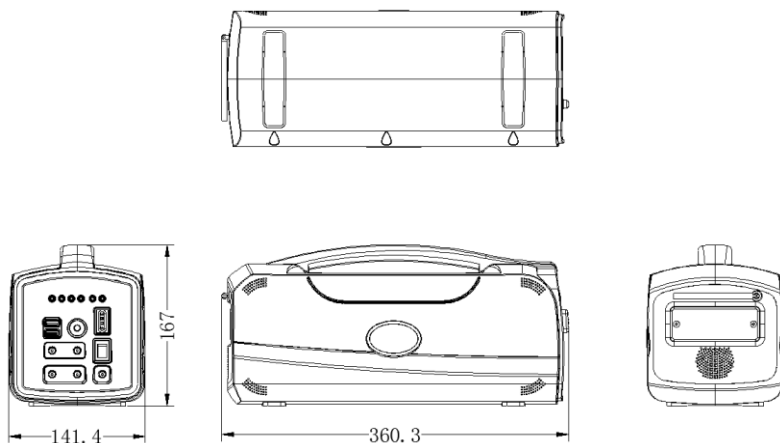

(Unit: mm)

Any changes without prior notice!

Version number: 1.0

HUIZHOU EPEVER TECHNOLOGY CO., LTD.

Beijing Tel: +86-10-82894896/82894112

Huizhou Tel: +86-752-3889706

E-mail: info@epsolarpv.com

Website: www.epsolarpv.com

www.epever.com