



MPPT Solar Charge Controller

User Manual



MSC2210N
MSC3210N
MSC4210N
MSC4215N

Contents

Important Safety Instructions	1
1 General Information.....	4
1.1 Overview	4
1.2 Appearance.....	6
1.3 Naming rules	7
1.4 Connection diagram	8
1.4.1 Battery mode	8
1.4.2 No-battery mode	8
2 Interface.....	10
2.1 Indicator	10
2.2 Button.....	11
2.3 Battery type	12
2.4 Battery voltage control parameters.....	12
2.5 Load output voltage and priority setting.....	15
2.6 Load operation mode	16
3 Installation.....	17
3.1 Attentions	17
3.2 PV requirements.....	17
3.3 Wire size	20
3.4 Mounting	22
4 Others	26
4.1 Protection	26
4.2 Troubleshooting.....	28
4.3 Maintenance.....	29

5 Specifications31
Annex I PV Conversion Efficiency Curves35
Annex 2 Load Conversion Efficiency Curves.....38





Important Safety Instructions

Please reserve this manual for future review.

This manual contains all instructions of safety, installation, and operation for MSC-N series Security Monitoring Maximum Power Point Tracking (MPPT) solar controller ("controller" as referred to in this manual).

1. Explanation of symbols

To enable users to use the product efficiently, as well as to ensure personal and property safety, please read related literature accompanying the following symbols.

Symbol	Definition
TIP	Indicate any practical advice for reference.
	IMPORTANT: Indicates a critical tip during the operation, if ignored, may cause the device to run in error.
	CAUTION: Indicates potential hazards, if not avoided, may cause the device damaged.
	WARNING: Indicates the danger of electric shock, if not avoided, would cause casualties.
	WARNING HOT SURFACE: Indicates the risk of high temperature, if not avoided, would cause scalds.
	Read the user manual carefully before any operation.

 WARNING	The entire system should be installed by professional and technical personnel.
---	--



2. Requirements for professional and technical personnel

- Professionally trained;
- Familiar with related safety specifications for the electrical system;
- Read this manual carefully and master related safety cautions.

3. Professional and technical personnel is allowed to do

- Install the controller to a specified location;
- Conduct trial operations for the controller;
- Operate and maintain the controller



4. Safety cautions before installation

 IMPORTANT	When you receive the controller, check whether there is any damage that occurred in transportation. Contact the transportation company or our company in time for any problem.
 CAUTION	<ul style="list-style-type: none">• When storing or moving the controller, follow the instructions in the manual.• When installing the controller, must evaluate whether the operation area exists any arc danger.
 WARNING	Keep the controller out of reach of children.

5. Safety cautions for mechanical installation

 WARNING	<ul style="list-style-type: none">• Before installation, make sure the controller has no electrical connection.• Ensure enough heat dissipation space for the controller before installation. Do not install the controller in a harsh environment such as humid, greasy, flammable, explosive, or dust accumulation.
---	--

6. Safety cautions for electrical connection

 CAUTION	Check whether all the wiring connections are tight to avoid the danger of heat accumulation due to loose connections.
 WARNING	The input of PV array is a high voltage, do not touch the wiring connection to avoid electric shock.

7. Safety cautions for controller operation:

 CAUTION	When the controller is running, please do not open the cabinet.
---	---

 WARNING HOT SURFACE	<p>When the controller is running, the heat sink will generate a lot of heat, and the temperature would be very high, please do not touch it.</p>
---	---

8. Dangerous operations which would cause electric arc, fire or explosion

- Touch the wire end that hasn't been insulation treated and maybe electriferous.
- Touch the wiring copper row, terminals, or internal modules of the controller that may be electriferous.
- Screw or other spare parts inadvertently falls into the controller.
- Improper operations by untrained non-professional or technical personnel.

 WARNING	<p>Once an accident occurs, it must be handled by professional and technical personnel. Improper operations would cause more serious accidents.</p>
---	---

9. Safety cautions for stopping the controller

- After the controller stop running for five minutes, the internal conductive modules could be touched;
- The controller is allowed to restart after removing the faults which affect the safety performance of the controller.
- There are no serviceable parts inside. If any maintenance service is required, please contact our service personnel.

10. Safety cautions for controller maintenance

- It is recommended to check the controller with testing equipment to ensure there is no voltage and current at all;
- When conducting electrical connection and maintenance, must post temporary warning sign or put up barriers to prevent unrelated personnel from entering the electrical connection or maintenance area;
- An improper operation to the controller may cause personal injury or equipment damage;
- Wear an antistatic wrist strap or avoid unnecessary contact with the circuit board to prevent electrostatic damage.

1 General Information

1.1 Overview

MSC-N series is a new generation of the solar controller with a two-way load output. The two-way load output voltage can be switched to 12V or 24V DC freely by an enable switch. According to the battery voltage, the two-way load output voltage can be turned off in stages to ensure the main load output. The two-way load output adopts a high-efficiency buck-boost conversion circuit, which greatly reduces the invalid loss of the battery and improves the service time of the battery.

The MPPT charging technology can fast track the max power point of solar panels in any situation and obtain the maximum energy in real-time. It can increase the utilization ratio of solar energy by 20%-30% compared with the PWM charging method. Charging current limit, charging power limit, and high temperature charging power automatic reduction of function, fully ensure the system stability of access to excess PV modules and high temperature running. Adaptive three-stage charging mode and comprehensive electronic protections such as over-charge, over-discharge, PV & battery reverse polarity, etc. effectively ensure the power supply safer, more stable, and more durable. MSC-N series controllers are most suitable for applications in the field of security monitoring, RV, and household system, etc.

Features

- High quality and low failure rate components of ST or IR to ensure the service life
- Advanced MPPT technology & ultra-fast tracking speed guarantee tracking efficiency up to 99.5%
- Maximum DC/DC transfer efficiency up to 98.6%, full load efficiency up to 96.6 %

- Accurate recognizing and tracking technology of multi-peaks maximum power point
 - Wider MPP running voltage to increase the utilization ratio of PV modules
 - Support the lead-acid and lithium batteries, programmable temperature compensation
 - High temperature charging automatic power reduction function
 - The freely set voltage level of the two-way load output, especially suitable for voltage-sensitive loads
 - Configurable cut-off voltage value for the two-way load output
 - Support no-battery mode, PV array powers the load directly ①
 - High-efficiency buck-boost control chip and power device, conversion efficiency up to 98.9%
 - Optional charging prior mode and load prior mode
 - Effectively prolong the running time of load one by the discontinuous power supply in load prior mode
 - Customized the load two output according to the actual requirement
 - Common negative design, used in a negative grounded system
 - Real-time monitor controller by an external remote meter, BT module, Wifi module or PC software
 - Comprehensive electronic protections
- ① **Set the rated voltage level of the battery to auto recognition mode through the PC software or the remote meter, and the controller will be in no-battery mode.**

1.2 Appearance

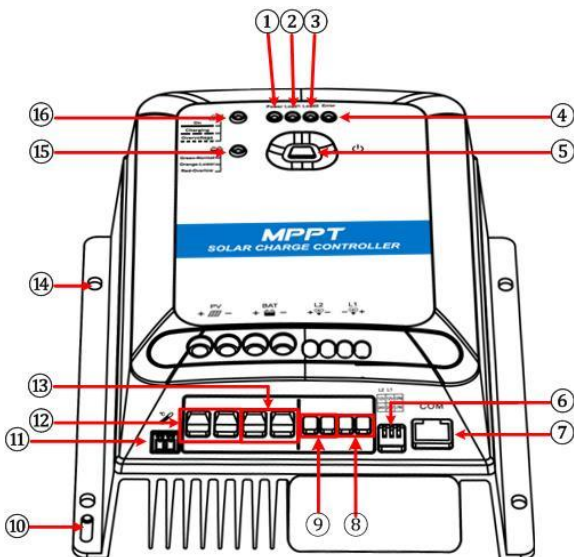

①	Power Indicator	⑨	Load 2 Terminals
②	Load 1 indicator	⑩	Grounding terminal
③	Load 2 indicator	⑪	Temperature sensor interface ^②
④	Error codes	⑫	PV Terminals
⑤	Load ON/OFF and setting button	⑬	Battery Terminals
⑥	Load 1/Load 2/Prior Mode enable switch	⑭	Mounting Hole *4
⑦	RS485 communication port ^①	⑮	Battery indicator
⑧	Load 1 Terminals	⑯	PV Indicator

① Pin definition for the RS485 communication port

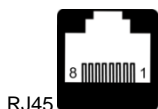

crystal head



Pin	Definition	Instruction
1/2	+5VDC	5V/200mA
3/4	RS485-B	RS485-B
5/6	RS485-A	RS485-A

 WARNING	Do not short circuit the positive and negative pins of the RS485 communication port; otherwise, it will damage the controller.
--------------------	--

- ② If the remote temperature sensor is not connected to the controller or damaged, the controller will charge or discharge the battery at the default temperature setting of 25°C (no temperature compensation).

1.3 Naming rules

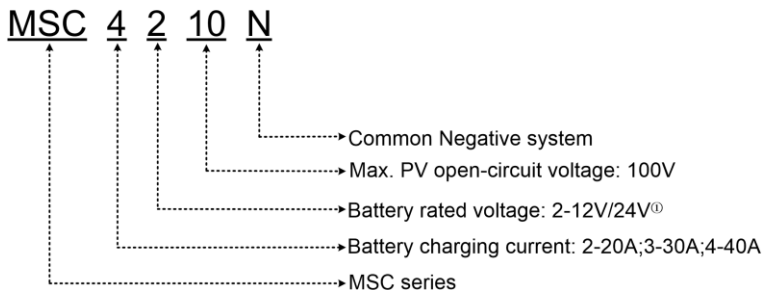

- ① For MSC4210N and MSC4215N, the rated voltage of the battery supports 24V only. For other MSC-N types, the rated voltage of the battery supports both 12V and 24V.

1.4 Connection diagram

1.4.1 Battery mode

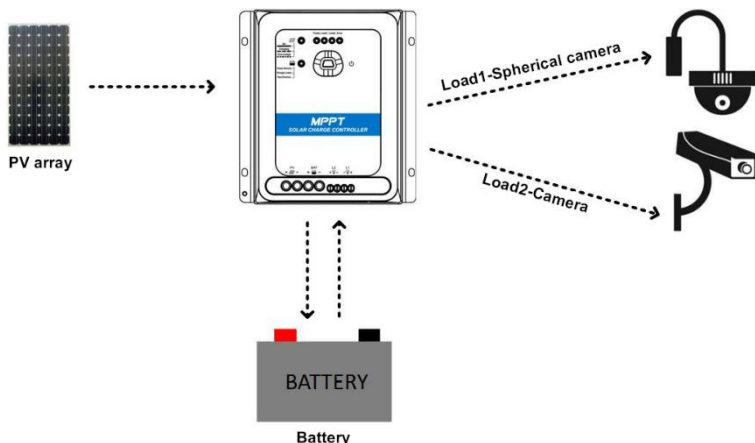

1.4.2 No-battery mode

Set the rated voltage level of the battery to auto recognition mode through the below methods; the controller will work in no-battery mode (it also can work in battery mode). In no-battery mode, the PV array will power the load directly.

- 1) In the **[Control Parameter]** interface of PC software, select **"Self-recognition"** for **[Rated Voltage Level]** parameter.
- 2) Set the rated voltage level to **[self]** through the remote meter. Detail settings refer to the MT92 user manual.



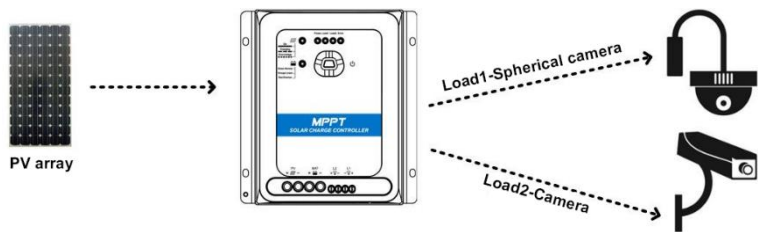

 CAUTION	<ul style="list-style-type: none">• Only when the PV power goes greater than the total load power, which cannot surge drastically, and the PV input voltage exceeds 30V, the load will work normally.• In the condition of two-way load, when the power of the PV array is lower than the total power of the loads but can meet the power of load 2, the output of load 2 is given priority. Load 1 will be turned off and restarted every 30 minutes until it can work normally.
---	--



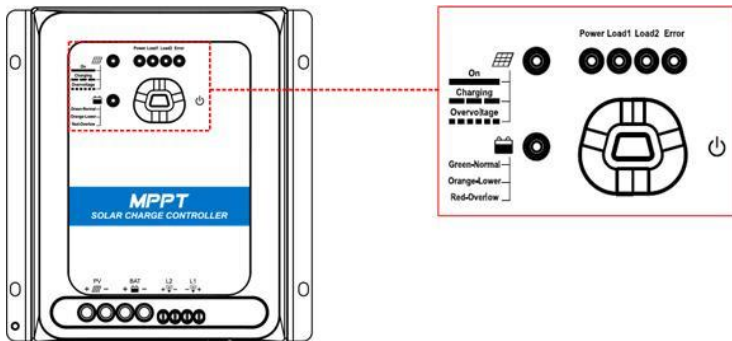



2 Interface

2.1 Indicator



Indicator	Color	Status	Definition
 	Green	ON solid	PV charges the battery with a low current
	Green	OFF	1. No sunlight 2. Connection error 3. Low PV voltage
	Green	Slowly Flashing(1Hz)	Normal charging
	Red	Fast Flashing (4Hz)	PV over voltage
 	Green	ON solid	Battery normal
	Green	Slowly Flashing(1Hz)	Battery full
	Green	Fast Flashing (4Hz)	Battery over voltage
	Orange	ON solid	Battery under voltage
	Orange	Slowly Flashing	Battery type setting

	Red	ON solid	Battery over discharged
	Red	Slowly Flashing(1Hz)	Battery over temperature
	Red	Fast Flashing (4Hz)	Lithium battery low temperature①
Power 	Green	ON solid	Controller normal Battery type: 12V Sealed
		Slowly Flashing	Battery type: 24V Sealed
Load1 	Green	ON solid	Load 1 ON Battery type: 12V Gel
		Slowly Flashing	Battery type: 24V Gel
Load2 	Green	ON solid	Load 2 ON Battery type: 12V LFP
		Slowly Flashing	Battery type: 24V LFP
Error 	Red	ON solid	Controller over temperature/fault Load over current/short circuit Battery type: 12V LNCM
		Slowly Flashing	Battery type: 24V LNCM
All Indicators fast flashing			System voltage error②

① When a lead-acid battery is used, the controller doesn't have the low temperature protection.

② When a lithium-ion battery is used, the system voltage can't be identified automatically.

2.2 Button

Click	1. Control the load ON/OFF First: Load 1 OFF, Second: Load 2 OFF; Third: Load 1 ON; Forth: Load 2 ON. 2 Select battery type (refer to "2.1 Indicator")
--------------	---

Press for 5s	Enter the Battery type setting interface
---------------------	---

2.3 Battery type

No.	Battery type	Definition
1	Sealed(default)	Select the battery type according to the indicator and button. Select the "User" on MT92 or PC software to set voltage point.
2	Gel	
3	LFP	
4	LNCM	
5	User	

2.4 Battery voltage control parameters

◆ Battery parameters

Below values are measured in the 12V/25 °C system; please double the values in the 24V system.

Battery type Voltage parameters	Sealed	GEL	User
Over Voltage Disconnect Voltage	16.0V	16.0V	9~17V
Charging Limit Voltage	15.0V	15.0V	9~17V
Over Voltage Reconnect Voltage	15.0V	15.0V	9~17V
Equalize Charging Voltage	14.6V	--	9~17V
Boost Charging Voltage	14.4V	14.2V	9~17V
Float Charging Voltage	13.8V	13.8V	9~17V
Boost Reconnect Charging Voltage	13.2V	13.2V	9~17V
VLVR (Low voltage reconnect voltage)	12.6V	12.6V	9~17V

Under Voltage Warning Reconnect Voltage	12.2V	12.2V	9~17V
Under Voltage Warning Voltage	12.0V	12.0V	9~17V
VLVD (Low Voltage Disconnect Voltage)	11.1V	11.1V	9~17V
Discharging Limit Voltage	10.6V	10.6V	9~17V
Equalize Duration	120 minutes	--	0~180 minutes
Boost Duration	120 minutes	120 minutes	10~180 minutes

• **The following rules must be observed when modifying the parameter values in User for a lead-acid battery.**

- A. Over Voltage Disconnect Voltage > Charging Limit Voltage ≥ Equalize Charging Voltage ≥ Boost Charging Voltage ≥ Float Charging Voltage > Boost Reconnect Charging Voltage.
- B. Over Voltage Disconnect Voltage > Over Voltage Reconnect Voltage
- C. Low Voltage Reconnect Voltage > Low Voltage Disconnect Voltage ≥ Discharging Limit Voltage.
- D. Under Voltage Warning Reconnect Voltage > Under Voltage Warning Voltage ≥ Discharging Limit Voltage;
- E. Boost Reconnect Charging voltage > Low Voltage Reconnect Voltage.

◆ **Lithium battery parameters**

Below values are measured in the 12V/25 °C system; please double the values in the 24V system.

Battery type Voltage control parameters	LFP	Li(NiCoMn)O2	User
Over Voltage Disconnect Voltage	15.6V	13.5V	9~17V
Charging Limit Voltage	14.6V	12.6V	9~17V
Over Voltage Reconnect Voltage	14.7V	12.7V	9~17V
Equalize Charging Voltage	14.5V	12.5V	9~17V

Boost Charging Voltage	14.5V	12.5V	9~17V
Float Charging Voltage	13.8V	12.2V	9~17V
Boost Reconnect Charging Voltage	13.2V	12.1V	9~17V
VLVR (Low voltage reconnect voltage)	12.8V	10.5V	9~17V
Under Voltage Warning Reconnect Voltage	12.8V	11.0V	9~17V
Under Voltage Warning Voltage	12.0V	10.5V	9~17V
VLVD (Low Voltage Disconnect Voltage)	11.1V	9.3V	9~17V
Discharging Limit Voltage	10.6V	9.3V	9~17V

• **The following rules must be followed when modifying the parameter values in User for a lithium battery.**

- A. Over Voltage Disconnect Voltage > Over Charging Protection Voltage (Protection Circuit Modules (BMS)) + 0.2V;
- B. Over Voltage Disconnect Voltage > Over Voltage Reconnect Voltage = Charging Limit Voltage ≥ Equalize Charging Voltage = Boost Charging Voltage ≥ Float Charging Voltage > Boost Reconnect Charging Voltage;
- C. Low Voltage Reconnect Voltage > Low Voltage Disconnect Voltage ≥ Discharging Limit Voltage.
- D. Under Voltage Warning Reconnect Voltage > Under Voltage Warning Voltage ≥ Discharging Limit Voltage;
- E. Boost Reconnect Charging voltage > Low Voltage Reconnect Voltage;
- F. Low Voltage Disconnect Voltage ≥ Over Discharging Protection Voltage (BMS) + 0.2V

 WARNING	<ul style="list-style-type: none"> • The voltage parameters of a lithium battery can be set according to the voltage parameters of lithium battery BMS. • The required accuracy of BMS shall be no higher than 0.2V. We will not assume any responsibility for the system abnormal when the accuracy of BMS is higher than 0.2 v.
---	---

2.5 Load output voltage and priority setting

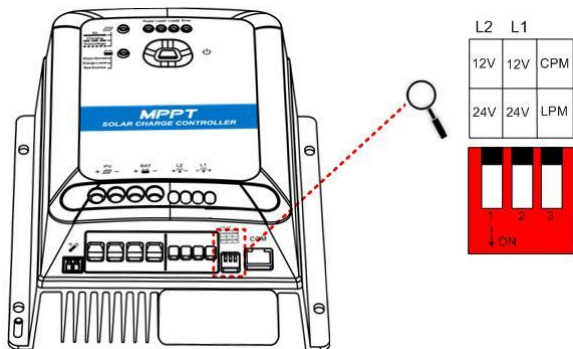

L2	Load 2 Output voltage	Set to OFF	Output 12V
		Set to ON	Output 24V
L1	Load 1 Output voltage	Set to OFF	Output 12V
		Set to ON	Output 24V
CPM/LPM	Load working Modes (only valid for load 2)	Set to OFF	CPM(Charging Prior Mode) (Default)
		Set to ON	LPM(Load prior mode ^①)

- ① The load prior mode will be enabled when the battery voltage reaches the low voltage disconnect voltage, and the PV array charging current reaches more than 7A for 10 minutes.

 WARNING	Before connecting loads, ensure the voltage level of load is equal to the output voltage level corresponding to the DIP switch. If the output voltage level is higher than the load voltage, the load may be damaged.
---	---

2.6 Load operation mode

Load	Working modes	Definition
Load 1	Manual mode(Default load ON)	<p>When the battery voltage reaches the Under Voltage Warning Voltage, the load output will be turned off.</p> <p>When the battery Voltage reaches the Under Voltage Warning Reconnect Voltage, the load output will resume.</p>
Load 2	Manual mode(Default load ON)	<p>✦ Set enable switch to CPM(default)</p> <p>When the battery voltage reaches the Low Voltage Disconnect Voltage (LVD) , the load output will be turned off.</p> <p>When the battery Voltage reaches the Low Voltage Reconnect Voltage, the load output will resume.</p> <p>✦ Set the enable switch to LPM^①</p> <p>Mode 1: When the battery voltage reaches the low voltage disconnect voltage, the charging current of the PV array reaches more than 7A for 10 minutes, the load output will be discontinuous. It will turn on for five minutes and then turn off for ten minutes. When the battery voltage reaches the low voltage reconnect voltage, the load output will resume.</p> <p>Mode 2: When the battery voltage reaches the low voltage disconnect voltage, the load output will be turned off. When the battery voltage reaches the low voltage reconnect voltage, the load output will resume.</p>

① Check or set the mode 1/2 by the PC software or remote meter only.

3 Installation

3.1 Attentions

- Be very careful when installing the batteries. Please wear eye protection when installing the open-type lead-acid battery, and rinse with clean water in time for any contact with battery acid.
- Keep the battery away from any metal objects, which may cause a short circuit of the battery.
- Acid gas may be generated when the battery is charged. Ensure that the surrounding environment is well ventilated.
- Avoid direct sunlight and rain infiltration when installing it outdoor.
- Loose connectors and corroded wires may result in high heat that can melt wire insulation, burn surrounding materials, or even cause a fire. Ensure tight connections and secure cables with cable clamps to prevent them from swaying in moving equipment.
- Only charge the lead-acid and lithium-ion batteries within the control range of this controller.
- The battery connector may be wired to another battery or a bank of batteries. The following instructions are for the use of a single battery. Still, they are also applicable to systems with a group of batteries.
- Select the system cables according to $5A/mm^2$ or less current density.

3.2 PV requirements

(1) Serial connection (string) of PV modules

As the core component of the solar system, it is important for the controller to suit various types of PV modules and to maximize the conversion of solar energy into

electricity. According to the open-circuit voltage (VOC) and the maximum power point voltage (VMPP) of the MPPT controller, the serial connection of PV modules suitable for different controllers can be calculated. The below table is for reference only.

MSC2210N/MS3210N/MS4210N:

System voltage	36cell Voc < 23V		48cell Voc < 31V		54cell Voc < 34V		60cell Voc < 38V	
	Max.	Best	Max.	Best	Max.	Best	Max.	Best
12V	4	2	2	1	2	1	2	1
24V	4	3	2	2	2	2	2	2

System voltage	72cell Voc < 46V		96cell Voc < 62V		Thin-Film Module Voc > 80V
	Max.	Best	Max.	Best	
12V	2	1	1	1	1
24V	2	1	1	1	1

NOTE: The above parameters are calculated under standard test conditions (STC (Standard Test Condition): Module Temperature 25°C, Air Mass1.5, Irradiance 1000W/m².)

MSC4215N

System voltage	36cell Voc < 23V		48cell Voc < 31V		54cell Voc < 34V		60cell Voc < 38V	
	Max.	Best	Max.	Best	Max.	Best	Max.	Best
12V	4	2	2	1	2	1	2	1
24V	6	3	4	2	4	2	3	2

System voltage	72cell Voc < 46V		96cell Voc < 62V		Thin-Film Module Voc > 80V
	Max.	Best	Max.	Best	
12V	2	1	1	1	1
24V	3	2	2	1	1

NOTE: The above parameter values are calculated under standard test conditions (STC (Standard Test Condition): Irradiance 1000W/m², Module Temperature 25°C, Air Mass1.5.)

(2) Max. PV Array Power

The MPPT controller has limit current /power function; namely, when the charging current/power exceeds the rated charging current/power, the controller will automatically limit the charging current/power to the rated charging current/power. This function can effectively protect the charging modules of the controller, and prevent damage to the controller due to excessive access to PV modules. The actual running status of PV array is as follows:

Condition 1: Actual charging power of PV array \leq Rated charging power of the controller

Condition 2: Actual charging current of PV array \leq Rated charging current of controller

When the controller works under "Condition 1" or "Condition 2", it will charge the battery as per the actual charging current; at this time, the controller can work at the maximum power point of PV array.

 WARNING	When the power of the PV array is lower than the rated charging power, the maximum open-circuit voltage is higher than 100V (MSC **10N)/150V (MSC **15N) at the lowest environmental temperature, the controller may be damaged.
---	--

Condition 3: Actual charging power of PV array $>$ Rated charging power of the controller

Condition 4: Actual charging current of PV array $>$ Rated charging current of controller

When the controller works under "Condition 3" or "Condition 4" , it will charge the battery as the rated charging current or rated charging.

 WARNING	When the power of the PV array is higher than the rated charging power, and the maximum open-circuit voltage is higher than 100V(MSC **10N)/150V(MSC **15N) at the lowest environmental temperature, the controller may be damaged.
---	---

According to the "Peak Sun Hour's diagram," if the power of the PV array exceeds the rated charging power of the controller, the charging time as per the rated power will be prolonged. More solar energy can be obtained to charge the battery. However, in the practical application, the maximum power of the PV array shall be not higher than 1.5 times the rated charging power of the controller. If the maximum power of the PV array exceeds the rated charging power of the controller too much, the power of the PV array will be wasted, and the open-circuit voltage will also increase. The probability of damage to the controller may increase. For the recommended maximum power of the PV array for this controller, please refer to the table below:

Model	Rated charge Charge current	Rated charge Charging Power	PV array Max. PV power	Max. PV open circuit voltage
MSC2210N	20A	260W/12V 520W/24V	390W/12V 780W/24V	92V(25°C)
MSC3210N	30A	390W/12V 780W/24V	580W/12V 1170W/24V	100V(lowest temperature)
MSC4210N	40A	1040W/24V	1560W/24V	138V(25°C)
MSC4215N	40A	1040W/24V	1560W/24V	150V(lowest temperature)

3.3 Wire size

The wiring and installation methods must conform to the national and local electrical code requirements.

➤ PV wire size

Since the output of the PV array can vary with the PV module's size, connection method, or sunlight angle, the minimum wire size can be calculated by the short circuit current(ISC) of PV array. Please refer to the value of ISC in the PV module specification. When PV modules connected in series, the total ISC is equal to any PV

module's ISC. When PV modules connected in parallel, the total ISC is equal to the sum of all PV module's ISC. The ISC of the PV array must not exceed the controller's maximum PV input current.

Please refer to the table as below:

Model	Max. PV input current	Max. PV wire size *
MSC2210N	20A	6mm ² /10AWG
MSC3210N	30A	10mm ² /8AWG
MSC4210N MSC4215N	40A	16mm ² /6AWG

 WARNING	<p>When the PV modules connected in series, the total voltage must not exceed the max. PV open circuit voltage 92V (MSC**10N), or 138V (MSC**15N) at 25°C environment temperature.</p>
---	--

➤ **Battery wire size**

The battery and load wire size must conform to the rated charge current, the reference size as below:

Model	Rated charge current	Battery wire size
MSC2210N	20A	6mm ² /10AWG
MSC3210N	30A	10mm ² /8AWG
MSC4210N MSC4215N	40A	16mm ² /6AWG

 CAUTION	<ul style="list-style-type: none"> • The wire size is only for reference. If there is a long distance between the PV array and the controller or between the controller and the battery, larger wires shall be used to reduce the voltage drop and improve the system performance. • For the battery, the recommended wire will be selected according to the conditions that its terminals are not connected to any additional inverter.
---	--

➤ **Load wire size**



Load 1

Output voltage	Output power	Max. output current	Recommended wire
12VDC	100W	8.33A	2.5mm ² /13AWG
24VDC	100W	4.17A	1.5mm ² /15AWG

Load 2

Output voltage	Output power	Max. output current	Recommended wire
12VDC	36W	3A	1mm ² /16AWG
24VDC	36W	1.5A	0.5mm ² /20AWG

3.4 Mounting

 WARNING	<ul style="list-style-type: none">• Risk of explosion! Never install the controller in a sealed enclosure with flooded batteries! Do not install the controller in a confined area where battery gas can accumulate.• Risk of electric shock! When wiring the solar modules, the PV array can produce a high open-circuit voltage, so turn off the breaker before wiring and be careful when wiring.
 CAUTION	<p>The controller requires at least 150mm of clearance above and below for proper airflow. Ventilation is highly recommended if mounted in an enclosure.</p>

Installation Procedure:

Step 1: Determine the installation location and heat-dissipation space

The controller requires at least 150mm of clearance above and below for proper airflow, shows as below figure.

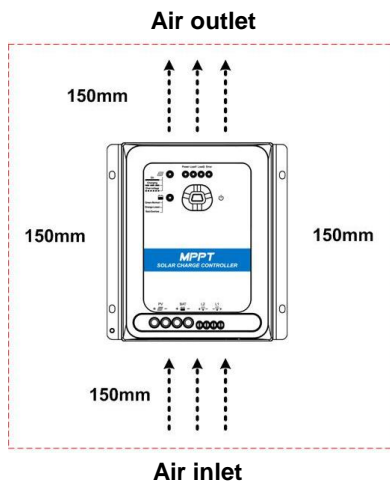

 CAUTION	<p>If the controller is to be installed in an enclosed box, it is important to ensure reliable heat-dissipation through the box.</p>
---	--

Step 2: Connect wires according to the sequence of ① load 1-- ② load 2-- ③ battery -- ④ PV array.

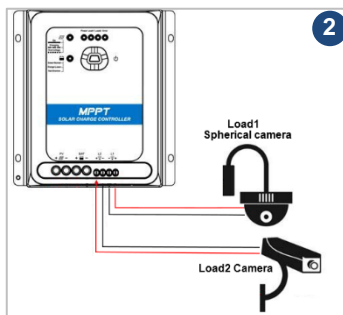
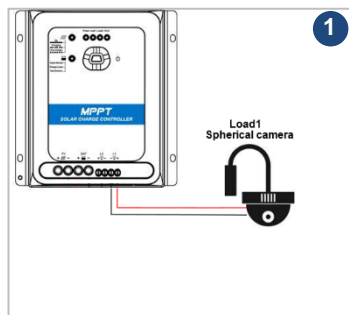

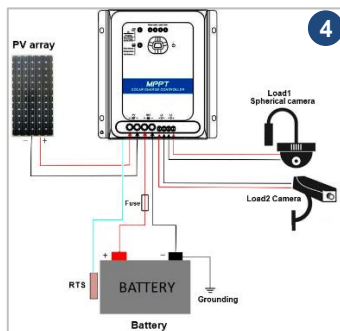
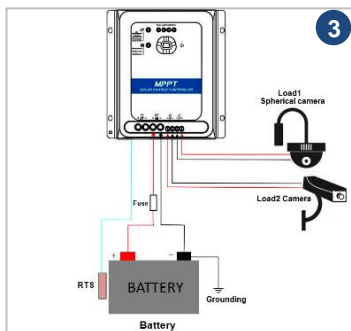

Note: Disconnect the system in the reverse order. Namely, disconnect the system in the order of ④ PV array -- ③ battery -- ② load 2-- ① load 1.



CAUTION

- When wiring the controller, please do not close the circuit breaker or fuse and make sure that the leads of "+" and "-" poles are connected correctly.
- A fuse which current is 1.25 to 2 times the rated current of the controller must be installed on the battery side with a distance from the battery no longer than 150 mm.
- If the controller to be used in areas of frequent lightning strikes or unsupervised areas, an external surge arrester must be installed on the input side of the PV array.
- If an inverter is to be connected to the system, connect the inverter directly to the battery, not to the load side of the controller.

Step 3: Grounding

MSC-N series are common-negative controllers; all the negative terminals can be grounded at the same time, or any one of them is grounded. However, according to the practical application, the negative terminals of PV array, battery, and load can also be ungrounded. Still, the load grounding terminal on the shell must be grounded, it effectively shields the electromagnetic interference from the outside, and prevent some electric shock to the human body.

 CAUTION	<p>For a common-negative system, such as the RV system, it is recommended to use a common-negative controller. If a common-positive controller is used and the positive electrode is grounded in the common-negative system, the controller may be damaged.</p>
---	---

Step 4: Connect the remote temperature sensor

Connect the remote temperature sensor to interface ⑪ and place the other end close to the battery.



Included Accessory:

(Model: RT-MF58R47K3.81A)



Optional Accessory:

(Model: RTS300R47K3.81A)

 CAUTION	<p>If the remote temperature sensor is not connected to the controller or damaged, the controller will charge or discharge the battery at the default temperature of 25°C (no temperature compensation).</p>
---	--

Step 5: Power on the controller

Closing the battery fuse will power on the controller. Check the status of the battery indicator (green ON solid of the indicator states controller is operating normally).

Close the fuse and circuit breaker of the load and PV array; the system will working in the preprogrammed mode.

 CAUTION	<p>If the controller cannot work properly or the battery indicator shows an abnormality, please refer to <u>4.2 "Troubleshooting."</u></p>
---	---

4 Others

4.1 Protection

Protection	Instruction
PV limit Current/limit power protection	When the charging current/power of the PV array exceeds the rated charging current/power, the PV array will charge the battery as per the rated charging current/power.
PV short circuit protection	When not in the PV charging state, the controller will not be damaged in the case of a short-circuiting in the PV array.
PV reverse polarity protection	When the polarity of the PV array is reversed, the controller may not be damaged and resume normal operation after the mis-wiring is corrected. NOTE: If the PV array is reversed and the actual power of the PV array is 1.5 times the rated power of the controller, the controller will be damaged.
Night reverse charging protection	Prevent the battery from discharging to the PV module at night.
Battery reverse protection	When the polarity of the battery is reversed, the controller may not be damaged and resume normal operation after the mis-wiring is corrected. NOTE: Limited to the characteristic of lithium battery, when the PV array connection right and battery connection reversed, the controller will be damaged.
Battery over voltage protection	When the battery voltage reaches the over voltage disconnect voltage, the PV array will automatically stop charging the battery to prevent battery damage due to over charging.
Battery over discharging protection	When the battery voltage reaches the low voltage disconnect voltage, battery discharging will be automatically stopped to prevent battery damage due to over discharging.

Battery over heating protection	The controller detects the battery temperature through an external temperature sensor. The battery will stop working when its temperature exceeds 65 °C and will resume when its temperature is below 55 °C.
Lithium battery low temperature protection	When the temperature detected by the temperature sensor is lower than the Low Temperature Protection Threshold (LTPT), the controller will stop charging and discharging automatically. When the detected temperature is higher than the LTPT, the controller will be working automatically (The LTPT is 0 °C by default and can be set within the range of 10 ~ -40 °C).
Load short circuit protection	When the load is short-circuited, the controller will cut off the output and automatically resume the output when the short circuit is released.
Overload protection	If the load current exceeds 1.05 times the controller's rating current, the controller will cut off the output after 30 seconds delay. In case of overload, the controller is restarted at intervals of 5 seconds, 10 seconds, 15 seconds, 20 seconds, 25 seconds, 30 seconds and 1 hour until the power of all the loads is reduced to the rated power.
Device over heating protection	An internal temperature sensor can detect the internal temperature of the controller. The controller stops working when the internal temperature exceeds 85 °C and resume work when the internal temperature is below 75 °C.
TVS high voltage transients protection	The internal circuitry of the controller is designed with Transient Voltage Suppressors (TVS), which can only protect against high-voltage surge pulses with less energy. If the controller is to be used in an area with frequent lightning strikes, it is recommended to install an external surge arrester.

When the internal temperature of the controller reaches 81°C, the charging power automatic reduction function will be enabled. Every increase of one °C, the charging power will be reduced by 5%, 10%, 20%, and 40%. If the internal temperature is higher than 85°C, the

controller will stop charging the battery. When the internal temperature of the controller declines to 75 °C or lower, the controller will resume.

For example MSC4215N 24V system:

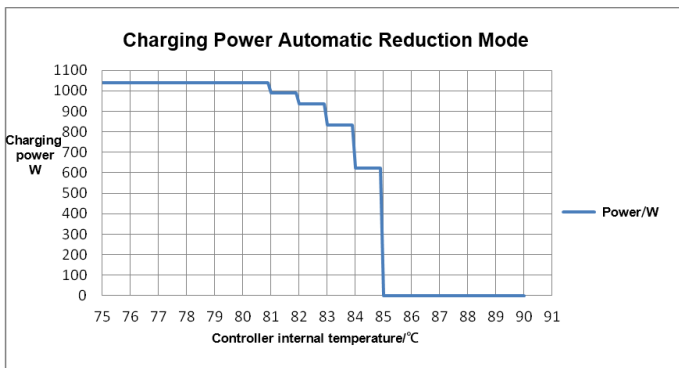

4.2 Troubleshooting

Faults	Possible reasons	Solutions
Charging LED is OFF during daytime when sunshine falls on PV array properly	PV array open circuit	Confirm whether the connection of PV array is correct and tight
Wire connection is correct; the controller is not working.	Battery voltage is lower than 8V	Please check the voltage of the battery(at least 8V voltage to activate the controller).
Charging indicator Green fast flashing	Battery over voltage	Check whether the battery voltage is higher than OVD (over voltage disconnect voltage), and disconnect the PV array connection.
The battery indicator is in red on solid	Battery over discharged	① Automatically restore load output after the battery is fully charged. ②Other ways recharge the battery.

Battery indicator flashes red slowly	Battery over heating	While the temperature decline to be below 55 °C, the controller will resume.
Fault indicator on solid, PV and battery Indicators flash orange fast	Controller over heating	When the heat sink of the controller exceeds 85°C, the controller will automatically cut off the input and output circuit. When the temperature below 75°C, the controller will resume work.
	System voltage error	① Check whether the current battery voltage matches the system voltage set by the controller. ② Please change a suitable battery or reset the system voltage.
Fault indicator on solid, load off.	Over load ^①	① Please reduce the number of electric equipment. ② Restart the controller or press the button to clear faults.
Fault indicator on solid, load off.	Load short circuit	① Check carefully loads connection, clear the fault. ② Restart the controller, or press the button to clear faults.

① If the load current exceeds 1.05 times the controller's rating current, the controller will cut off the output after 30 seconds delay. In case of overload, the controller is restarted at intervals of 5 seconds, 10 seconds, 15 seconds, 20 seconds, 25 seconds, 30 seconds and 1 hour until the power of all the loads is reduced to the rated power.

4.3 Maintenance

The following inspections and maintenance tasks are recommended at least two times per year for the best performance.

- Make sure no block on airflow around the controller. Clear up any dirt and fragments on the radiator.
- Check all the naked wires to make sure insulation is not damaged for sun exposure, frictional wear, dryness, insects or rats, etc. Repair or replace some

wires if necessary.

- Verify the indicator display is consistent with the actual operation. Pay attention to any troubleshooting or error indication. Take corrective action if necessary.
- Confirm that all terminals have no corrosion, insulation damaged, high temperature or burnt/discolored sign, tighten terminal screws to the suggested torque.
- Clear up dirt, nesting insects, and corrosion in time.
- Replace a new surge arrester in time to avoid damaging the controller and even other equipment.



WARNING

Risk of electric shock! Make sure that all the power is turned off before the above operations, and then follow the corresponding inspections and operations.

5 Specifications

Electrical Parameters

Model	MSC2210N	MSC3210N	MSC4210N	MSC4215N
Battery rated voltage	12/24VDC ★ Auto-recognition		24VDC	24VDC
Rated charging current	20A	30A	40A	40A
Controller working voltage range	8~32V	8~32V	16~32V	16~32V
Max. PV open circuit voltage	100V(At minimum operating environment temperature) 92V(At 25°C environment temperature)			150V(At minimum operating environment temperature) 138V(At 25°C environment temperature)
MPPT voltage range	(Battery voltage +2V)~72V			(Battery voltage +2V)~108V
Rated charging power	260W/12V 520W/24V	390W/12V 780W/24V	1040W/24V	
Max. conversion efficiency	98.3%	98.6%	98.6%	
Full load efficiency	96.4%	96.6%	96.5%	
Self-consumption	≤35mA(12V) ≤22mA(24V)			
Load 1/2 constant-voltage output voltage	DC 12V/24V (configurable)			

Load rated power	Load 1: 100W Load 2: 36W
Load output protection voltage	Load 1: Under Voltage Warning Voltage (it can be set when the battery type is "USER.") Load 2: Low Voltage disconnect Voltage (it can be set when the battery type is "USER.")
Max. load conversion efficiency	Load 1 98.9% Load 2 97.1%
Full load conversion efficiency	Load 1 97.4% Load 2 96.0%
No battery mode	Support
Load output voltage accuracy	12VDC --load 1: $\leq 0.4\%$; load 2: $\leq 0.1\%$ 24VDC --load 1: $\leq 0.9\%$; load 2: $\leq 1.1\%$
Load ripple voltage	100mV
Load ripple current	200mA
Load adjustment rate	$\leq 1\%$
LINEAR adjustment rate	$< 0.5\%$
Temperature compensate coefficient◆	$-3mV/^{\circ}C/2V$ (Default)
Grounding Type	Common negative
Communication port	RS485
Altitude❖	≤ 5000 (when the altitude exceeds 3000M, the load power will be reduced appropriately; working of full load is not supported.)

Protections	PV limit current/ limit power/short circuit/reverse /night reverse charging protection Lithium Battery reverse/over voltage/over discharging/over heating/low temperature charging and discharging protection Load short circuit/overload protection, controller over heating protection, against transient
-------------	---

- ★ When an LFP or LNCM battery is used, the system voltage can't be identified automatically. Please confirm the system voltage before operating.
- ◆ When an LFP or LNCM battery is used, the temperature compensation coefficient will be 0, and can't be changed.
- ❖ Under 3000M, working of full load is supported. When the altitude exceeds 3000M, the load power will be reduced appropriately. The load power variation curve with altitude is shown in the figure below:

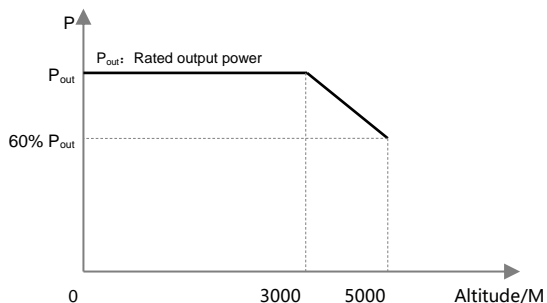

Environmental Parameters

Environment temperature※	-30°C~+65°C (when the working temperature reaches 50°C, the load power will be reduced appropriately; working of full load is not supported.)
Storage temperature	-30 °C~ +70 °C
Relative humidity	< 95% (N.C.)
Enclosure	IP30

- ※ During -30°C~+50°C, the controller can full load work. When the internal temperature of the controller exceeds 81°C, the charging power automatic reduction function will be enabled. Details refer to [4.1 protections](#). When the working environment temperature

exceeds 50°C, the actual load power needs to be derated. Every increasing 1°C in temperature, the actual load power needs to be reduced by 2.57% of the rated load power. For example, when the working temperature reaches 60°C, the actual rated power for load 1 will be $100W - 0.0257 \cdot (60 - 50) \cdot 100 = 74.3W$. The load power variation curve with temperature is shown in the figure below:

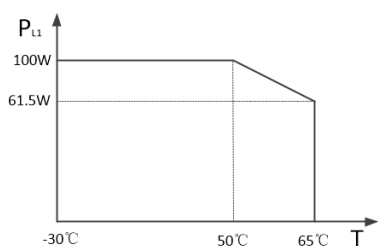

Load 1 Power reduction curve

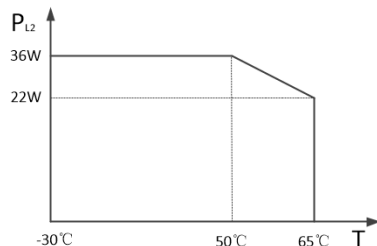

Load 2 Power reduction curve

Mechanical parameters

Model	MSC2210N	MSC3210N	MSC4210N	MSC4215N
Dimension	173×158×77.1 mm	178×162×80.1 mm	213.2×192×96.6mm	
Mounting size	120×149mm	120×153mm	150×182mm	
Mounting hole size	Φ5mm			
Grounding terminal	RNB14-5			
Recommended grounding cable	8AWG (10mm ²)	8AWG (10mm ²)	6AWG (16mm ²)	6AWG (16mm ²)
Net Weight	1.2kg	1.4kg	2.4kg	2.4kg

Annex I PV Conversion Efficiency Curves

Test condition: Illumination Intensity: $1000\text{W}/\text{m}^2$ Temperature: 25°C

◆ Model: MSC2210N

1. PV array Max. power point voltage(17V, 34V)/system voltage(12V)

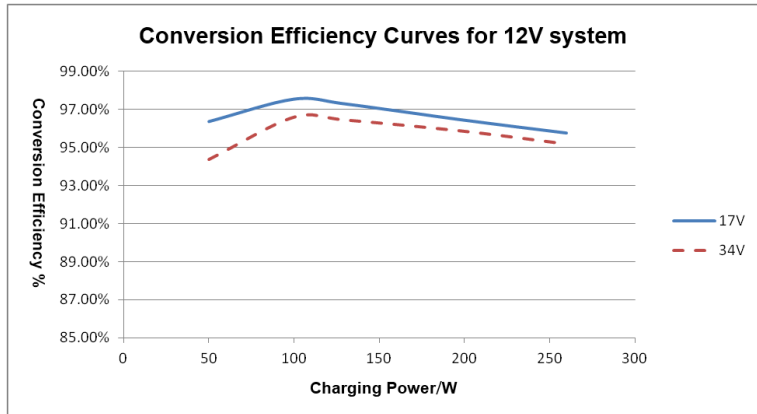

2. PV array Max. power point voltage(34V, 51V, 68V)/system voltage(24V)

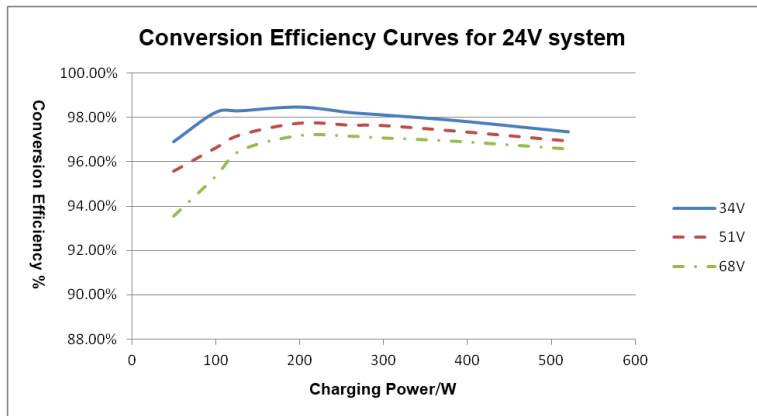

◆ **Model: MSC3210N**

1. PV array Max. power point voltage(17V, 34V)/system voltage(12V)

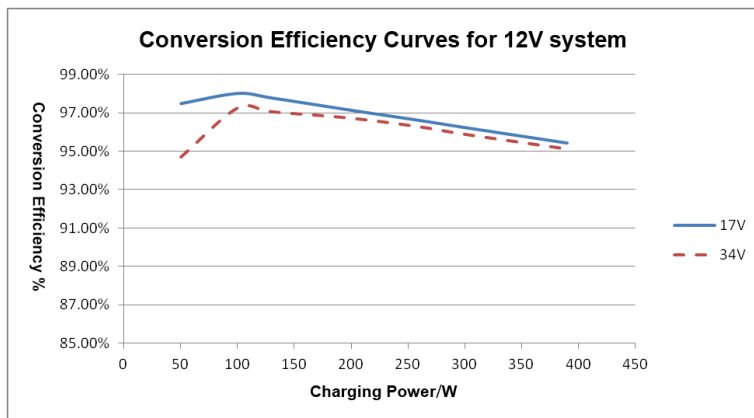

2. PV array Max. power point voltage(34V, 51V, 68V)/system voltage(24V)

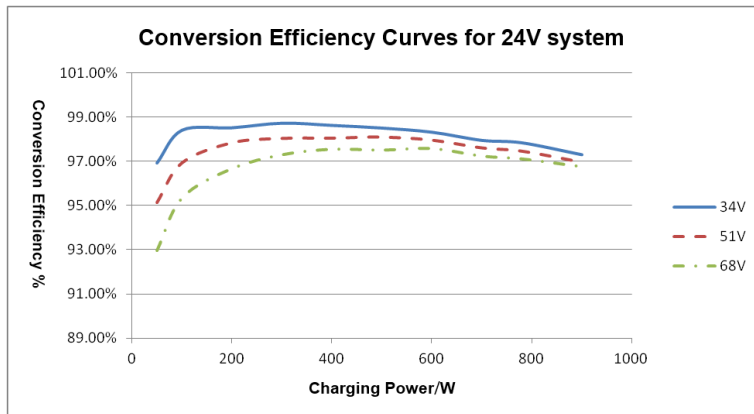

◆ **Model: MSC4210N**

PV array Max. power point voltage(34V, 51V, 68V)/system voltage(24V)

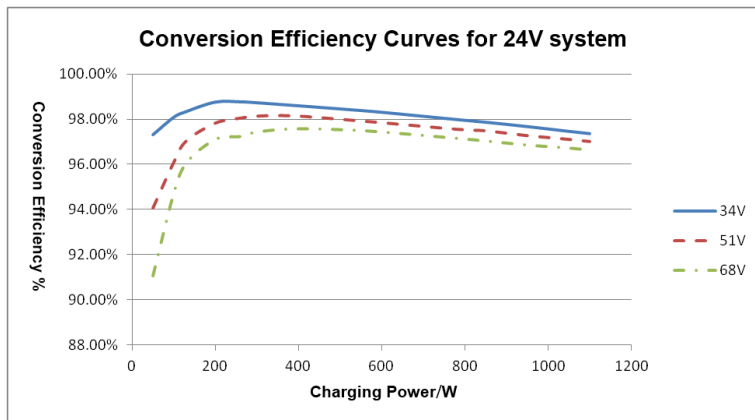

◆ **Model MSC4215N**

PV array Max. power point voltage(34V, 68V, 102V)/system voltage(24V)

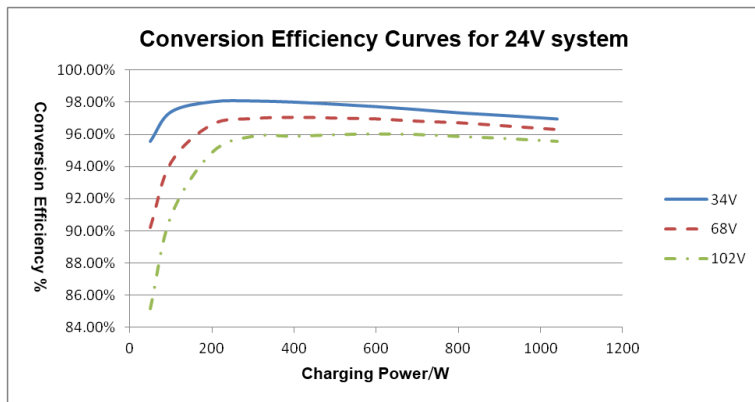

Annex 2 Load Conversion Efficiency Curves

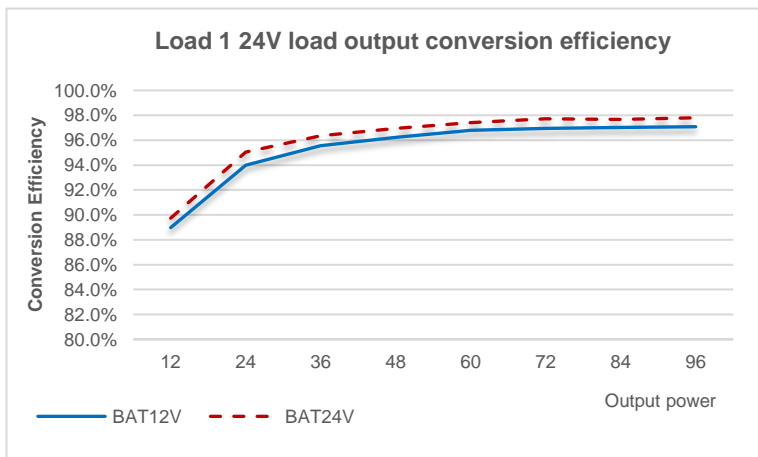
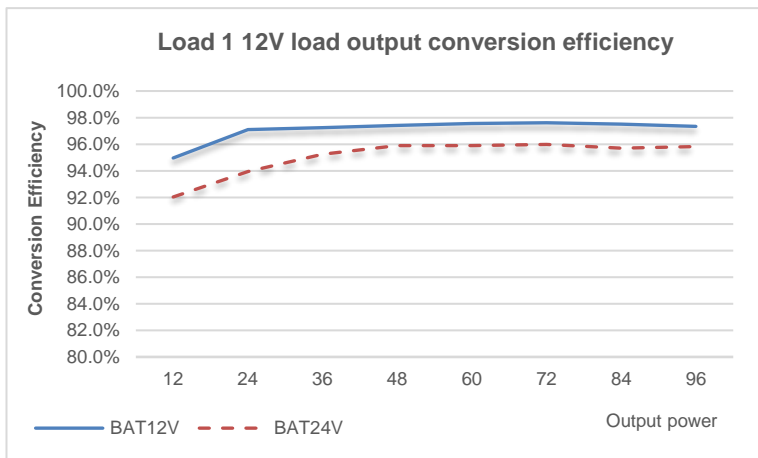

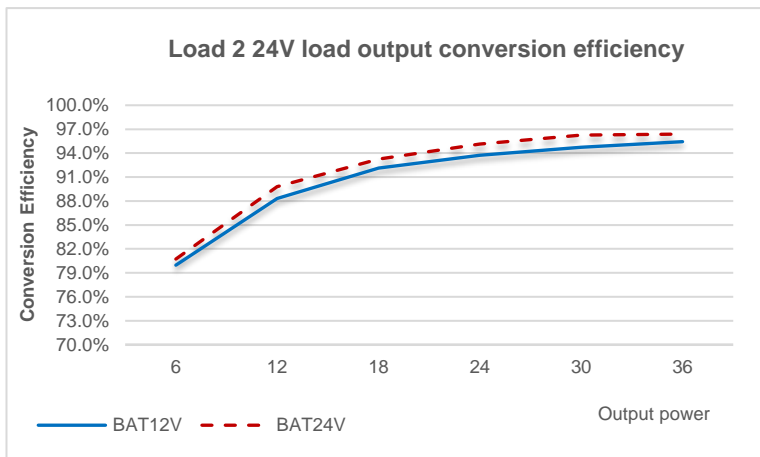
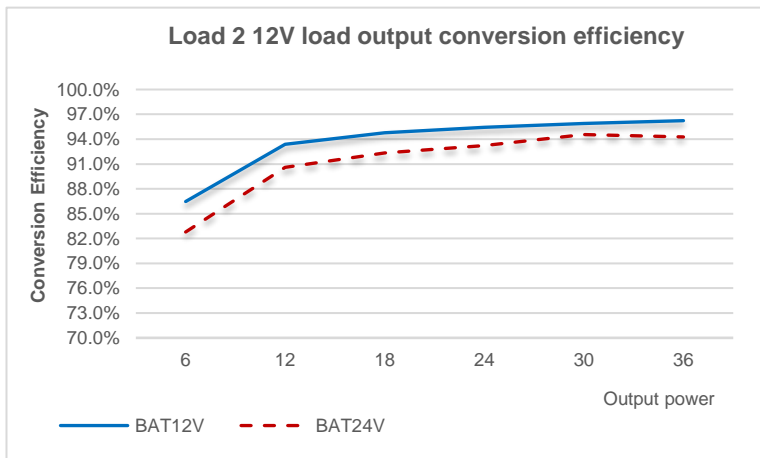

Any changes without prior notice! Version number: V1.3

HUIZHOU EPEVER TECHNOLOGY CO., LTD.

Beijing Tel: +86-10-82894896/82894112

Huizhou Tel: +86-752-3889706

E-mail: info@epever.com

Website: www.epever.com