



Inverter/charger

User Manual



HP2022-AH0750P20A

HP3522-AH1250P20A

HP3542-AH0650P20A

HP5542-AH1050P20A

Contents

Important Safety Instructions	1
Disclaimers	5
1 General Information	6
1.1 Overview.....	6
1.2 Appearance.....	9
1.3 Naming rules.....	12
1.4 Connection diagram.....	13
2 Interface	15
2.1 Indicator.....	15
2.2 Buttons.....	16
2.3 Home screen.....	17
2.4 Interface.....	18
2.4.1 Real-time data interface.....	18
2.4.2 User interface.....	20
2.4.3 Administrator interface.....	21
2.5 Parameters setting.....	22
2.5.1 Parameters list.....	22
2.5.2 Battery work modes.....	36
2.5.3 Battery voltage control parameters (Smart).....	44
2.5.4 Battery voltage control parameters (Expert).....	44
2.5.5 Time setting.....	47
2.5.6 Password modifying.....	48
3 Single Installation	49
3.1 Attention.....	49

3.2 Wire and breaker size.....	50
3.3 Mounting the inverter/charger.....	52
3.4 Wiring the inverter/charger.....	53
3.5 Operate the inverter/charger.....	61
4 Working modes.....	63
4.1 Abbreviation.....	63
4.2 Battery mode.....	63
4.2.1 Scenario A: Both PV and Utility are not available.....	63
4.2.2 Scenario B: PV is available, but the Utility is not available.....	64
4.2.3 Scenario C: Both PV and Utility are available.....	65
4.2.4 Scenario D: The PV is not available, but the Utility is available.....	68
4.3 No battery mode.....	70
5 Protections.....	71
6 Troubleshooting.....	75
6.1 Battery faults.....	75
6.2 PV faults.....	77
6.3 Inverter faults.....	78
6.4 Utility faults.....	80
6.5 Load faults.....	81
6.6 Other faults for single inverter/charger.....	82
6.7 BMS faults.....	83
7 Maintenance.....	84
8 Specifications.....	85





Important Safety Instructions

Please reserve this manual for future review.

This manual contains all the safety, installation, and operation instructions for the HP-AHP20A series inverter/charger ("inverter/charger" referred to as this manual).

1. Explanation of symbols

To enable users to use the product efficiently and ensure personal and property safety, please read the related words carefully when you encounter the following symbols in the manual.

Symbol	Definition
Tip	Indicates any practical advice for reference
	IMPORTANT: Indicates a critical tip during the operation, if ignored, may cause the device to run in error.
	CAUTION: Indicates potential hazards, if not avoided, may cause the device damage.
	WARNING: Indicates the danger of electric shock, if not avoided, would cause casualties.
	WARNING HOT SURFACE: Indicates the risk of high temperature, if not avoided, would cause scalds.
	Read the user manual carefully before any operation.

 WARNING:	The entire system should be installed by professional and technical personnel.
--	--



2. Requirements for professional and technical personnel

- Professionally trained.
- Familiar with related safety specifications for the electrical system.
- Read this manual carefully and master related safety cautions.

3. Professional and technical personnel is allowed to do

- Install the inverter/charger to a specified location.
- Conduct trial operations for the inverter/charger.
- Operate and maintain the inverter/charger.



4. Safety cautions before installation

 CAUTION	When receiving the inverter/charger, please check if there is any damage in transportation. If you find any problem, please contact the transportation company or our company in time.
 CAUTION	<ul style="list-style-type: none">• When installing or moving the inverter/charger, follow the instructions in the manual.• When installing the inverter/charger, end-users must evaluate whether the operation area exists arc danger.
 WARNING	Keep the inverter/charger out of the reach of children.



5. Safety cautions for mechanical installation

 WARNING	<ul style="list-style-type: none">• Before installation, confirm the inverter/charger has no electrical connection.• Ensure enough heat dissipation space for the inverter/charger before installation.• Do not install the inverter/charger in humid, salt spray, corrosion, greasy, flammable, explosive, dust accumulative, or other severe environments.
---	--

6. Safety cautions for electrical connection

 CAUTION	<ul style="list-style-type: none">• Check whether wiring connections are tight to avoid the danger of heat accumulation due to loose connections.• The inverter/charger shell shall be connected to the ground. The cross-section of the connection wire should not be less than 4mm²• A fast-acting fuse or breaker, whose rated current is twice the inverter/charger rated input current, should be used between the battery and the inverter/charger.• DO NOT put the inverter/charger close to the flooded lead-acid battery because the sparkle in the terminals may ignite the hydrogen released by the battery.
 WARNING	<ul style="list-style-type: none">• Do NOT connect the inverter/charger to another power source or Utility. Otherwise, the inverter/charger will be damaged.• The AC output terminal is only for the load connection, turn off the inverter/charger when connecting loads.• It is strictly forbidden to connect a transformer or a load with a surge power (VA) exceeding the overload power at the AC output port. Otherwise, damage will be caused to the inverter/charger.• Both the utility input and AC output are of high voltage, do not touch the wiring connection to avoid electric shock.

7. Safety cautions for inverter/charger operation

 WARNING HOT SURFACE	When the inverter/charger works, the shell will generate much heat, and the temperature is very high. Please do not touch it, and keep it far from the equipment susceptible to high temperature.
 CAUTION	<ul style="list-style-type: none">• When the inverter/charger is working, please do not open the inverter/charger cabinet to operate.• When eliminating the fault that affects the safety performance of the inverter/charger or disconnecting the DC input, turn off the inverter/charger switch and operate it after the LCD is completely OFF.

8. The dangerous operations would cause an electric arc, fire, or explosion.

- Touch the wire end that hasn't been insulation treated and may be electriferous.
- Touch the wiring copper row, terminals, or internal devices that may be electriferous.
- The connection of the power cable is loose.
- Screw or other spare parts inadvertently falls into the inverter/charger.
- Improper operations are carried out by untrained non-professional or technical personnel.

 WARNING	Once an accident occurs, it must be handled by professional and technical personnel. Improper operations would cause more serious accidents.
---	--

9. Safety cautions for stopping the inverter/charger

- First, turn off the AC output and disconnect the utility input breakers. Then, turn off the DC switch.
- After the input and output wires are disconnected for ten minutes, the internal conductive modules can be touched.
- No maintenance parts in the inverter/charger. If maintenance service is required, please get in touch with our after-sales service personnel.

 WARNING	Do NOT touch or open the shell after the inverter/charger is powered off within ten minutes.
---	--

10. Safety cautions for inverter/charger maintenance

- It is recommended to check the inverter/charger with testing equipment to ensure there is no voltage or current on the terminals and cables.
- When conducting the electrical connection and maintenance, post a temporary warning sign or put up barriers to prevent unrelated personnel from entering the electrical connection or maintenance area.

- Improper maintenance of the inverter/charger may cause personal injury or equipment damage;
- It is recommended to wear an antistatic wrist strap or avoid unnecessary contact with the circuit board.

 CAUTION	<p>The safety mark, warning label, and nameplate on the inverter/charger should be visible, not removed or covered.</p>
---	---

11. Working temperature

- Working temperature range: -20°C to +50°C (when the working temperature exceeds 30°C, the charging power and load power will be reduced appropriately. 100% load output is not supported.)
- Storage temperature range: -25°C to +60°C (No sharp temperature changing)
- Relative humidity: < 95% (Non-condensing)
- Altitude: < 4000m (If the altitude exceeds 2000 meters, the actual output power is reduced appropriately.)

 WARNING	<p>The inverter/charger is strictly prohibited from being used in the following places. And our company shall not be liable for any damage caused by being used in an inappropriate place.</p> <ul style="list-style-type: none"> • Do not install the inverter/charger in humid, salt spray, corrosion, greasy, flammable, explosive, dust accumulative, or other severe environments. Avoid direct sunlight and rain infiltration when installing it outdoors. • DO NOT install the inverter/charger and flooded lead-acid battery in a sealed space. Otherwise, a fire may cause when the terminals produce sparks, and it ignites the flammable gas released by the battery.
---	--

Disclaimers

The warranty does not apply to the following conditions:

- Damage caused by improper use or inappropriate environment (it is forbidden to install the inverter/charger in humid, salt spray, corrosion, greasy, flammable, explosive, dust accumulative, or other severe environments).
- The actual current/voltage/power exceeds the limit value of the inverter/charger.
- Damage caused by working temperature exceeding the rated range.
- Arc, fire, explosion, and other accidents caused by failure to follow the inverter/charger stickers or manual instructions.
- Unauthorized dismantling or attempted repair.
- Damage caused by force majeure.
- Damage occurred during transportation or handling.

1 General Information

1.1 Overview

The HP-AHP20A is a cost-effective hybrid inverter/charger that integrates charging and inverting functions. It supports charging from utility power, generators, and solar panels, as well as offering utility bypass, inverter output, and energy management capabilities. Additionally, it supports parallel operation for multiple units (12 units in standard application, more than 12 units need to be customized) in single phase and three phase, with 220VAC single phase or 380VAC three phase AC output.

The DSP chip in the product with an advanced control algorithm brings high response speed and conversion efficiency. In addition, this product adopts an industrial design to ensure high reliability and features multiple charging and output modes.

Adopt the Three-stage charging method (Bulk Charging, Constant Charging, and Float Charging) to ensure battery safety.

The large lattice LCD screen shows the operational status and full parameters.

The communication interface with the standard Modbus protocol allows end-users to expand their applications and is suitable for different monitoring requirements.

The new optimized MPPT tracking technology can fast-track the PV array's maximum power point in any sunlight conditions and obtain the maximum energy in real time. Two PV input (connect separately or connect in parallel) is supported, which improves the PV utilization.

Adopting the advanced control algorithm, the AC to DC charging process brings the full digital PFC and dual closed-loop voltage-current control. It enables the input power factor close to 1 and improves the control accuracy.

The fully smart digital DC to AC inverting process adopts the advanced SPWM technology, outputs a pure sine wave, and converts the DC power to AC power. It is suitable for household appliances, power tools, industrial equipment, audio systems, and other electronics.

End-users can choose energy sources according to actual needs to maximize solar energy utilization and flexibly take the Utility as a supplement in the hybrid system. This inverter/charger provides high-quality, high-stability, and high-reliability electric energy to the end-users by improving the solar system's power supply efficiency.

Features

- Full intelligent digital energy storage equipment.
- Support battery mode or non-battery mode.
- Non-battery mode: simultaneously charging with solar (Main) and Utility (Assist).
- Advanced SPWM technology and pure sine wave output.
- Parallel operation in single phase or three phase for 12 units in standard application^①
- PFC technology reduces the demand on the power grid capacity.
- Advanced MPPT technology, with maximum tracking efficiency higher than 99.5%.
- HP5542-AH1050P20A supports two PV inputs to improve PV utilization^②.
- Supports charging from multiple types of generators^③.
- Battery voltage controls the dry contact to turn on/off the external equipment.
- Battery charging or discharging current limit to compatible with different types of batteries.
- Maximum utility charging current settings to flexibly configure utility charging power.
- With the function of historical data recording^④, up to 25000, the interval of 15 minutes can be recorded for half a year (the interval time of 1 second to 3600 seconds settable)
- Multiple LED indicators show system status in real-time.
- One-button control of AC output.
- Large size LCD display for better status monitoring.
- RS485 communication interface with optional WiFi, Bluetooth, TCP, or 4G modules for remote monitoring.
- Three-stage charging method to ensure battery safety.
- Lithium battery communication port to perform the safe charging and discharging.
- Comprehensive electronic protection.
- -20°C to +50°C operating temperature range to meets more environment requirements.

① More than 12 units need to be customized.

② Only the HP5542-AH1050P20A supports two PV input function, which realizes single MPPT tracking or two parallel MPPTs tracking, and increase the PV maximum input current. When two PV arrays are independently input, set the "PV mode" as "ALL SINGLE." When two PV arrays connected in parallel to one access to the inverter/charger (the PV terminals of the inverter/charger need to be paralleled externally), set the "PV mode" as "ALL MULTIPLE." When there is only one PV array, the "PV mode"

is "ALL SINGLE" by default, The "ALL MULTIPLE" is invalid.

- ③ When connecting a non-inverter generator, the charging current maybe cannot reach the rated power. It is recommended to connect an inverter generator. And when using the generator, the "AC Input mode" needs to be set to the "Generator." For specific setting, refer to chapter [2.5.1 Parameters list](#).
- ④ The contents of each historical record include: Year, Month, Day, Hour, Minutes, Seconds, PV Maximum Voltage(V), PV Power(W), Utility Voltage(V), Utility Current(A), Utility Frequency(Hz), Utility Power(W), Load Voltage(V), Load Current(A), Load Power(W), Inverter Frequency(Hz), Battery Voltage(V), Battery Current(A), Battery SOC(%), Battery Temperature (°C), Boost Module Temperature(°C), INV Module Temperature(°C), Maximum BAT Volt(V), Minimum BAT Volt(V).

1.2 Appearance

- HP3522-AH1250P20A / HP3542-AH0650P20A / HP2022-AH0750P20A

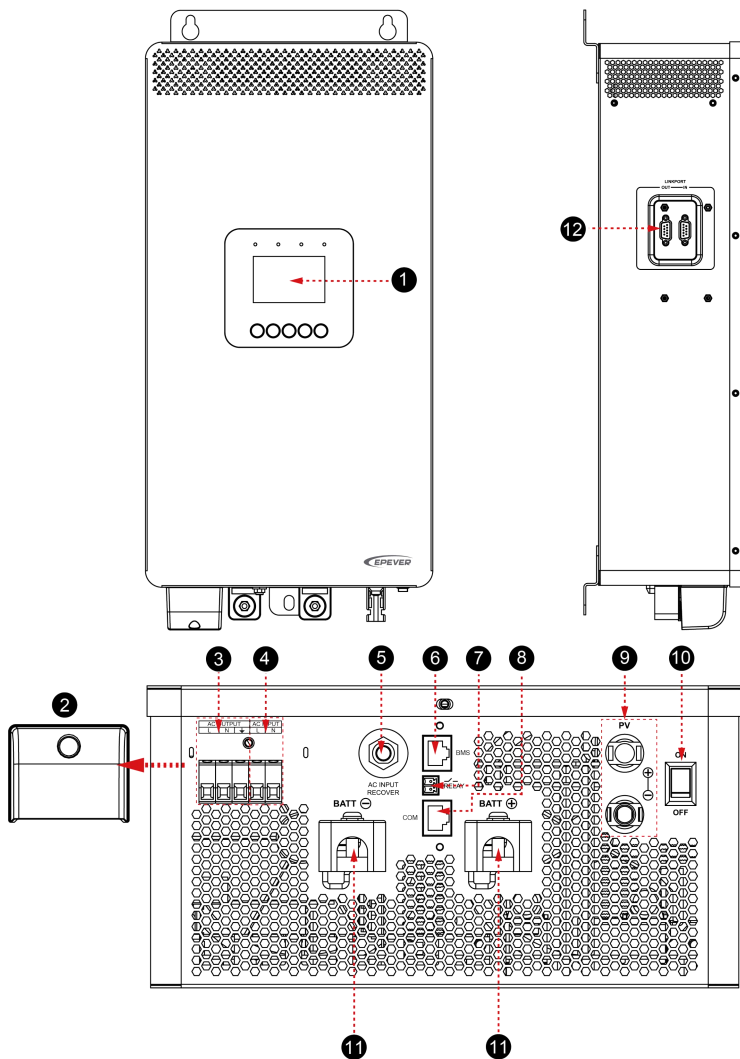

- HP5542-AH1050P20A

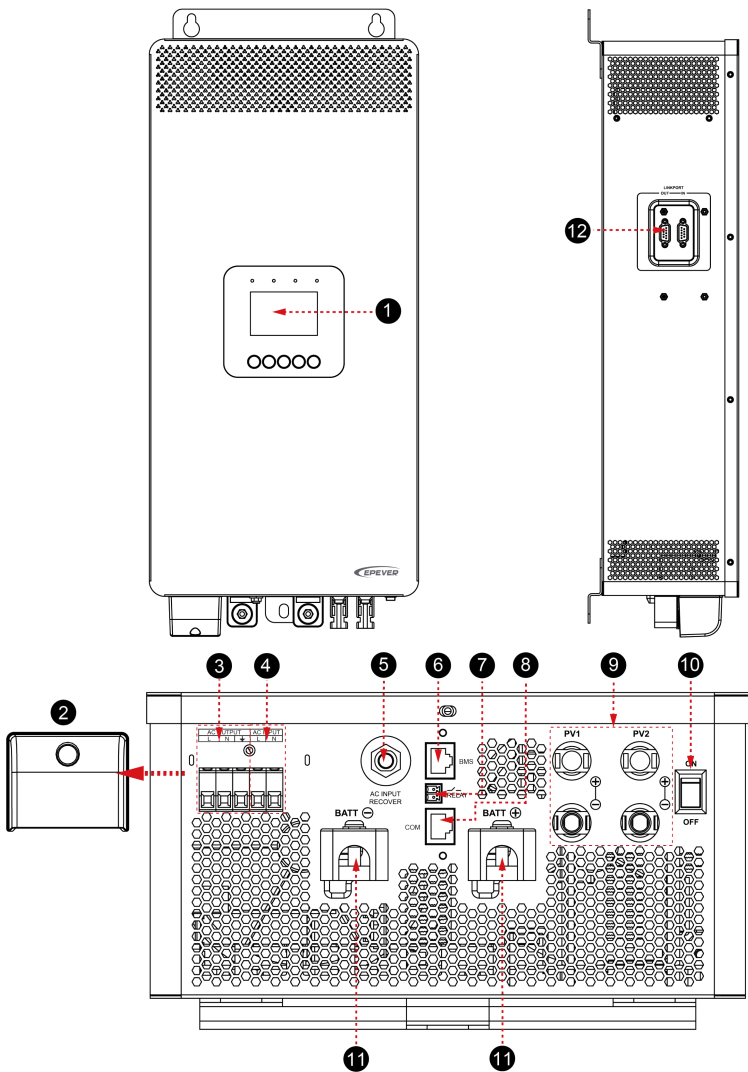

No.	Instruction	No.	Instruction
1	LCD (see chapter 2)	7	Dry contact interface ⁽²⁾
2	Terminal cover	8	RS485 port (RJ45, with isolation design) ⁽³⁾ 5VDC/200mA
3	AC input port	9	PV terminals
4	AC output port	10	Power switch
5	Utility over-current protector	11	Battery terminals
6	BMS port (RJ45, with isolation design) ⁽¹⁾	12	Parallel connection interface ⁽⁴⁾

- (1) This inverter charger integrates BMS-Link module, different lithium battery manufacturers' BMS protocols can be converted into our company's standard BMS protocol. In addition, it realizes the communication between the inverter/charger and the BMS. Pin definition for the BMS port (RJ45):

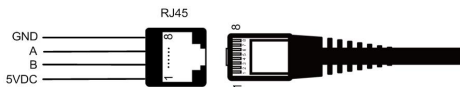

Pin	Definition	Pin	Definition
1	+5VDC	5	RS485-A
2	+5VDC	6	RS485-A
3	RS485-B	7	GND
4	RS485-B	8	GND

Tip	Please go to EPEVER official website to check or download the currently supported BMS manufacturers and the BMS parameters.
------------	---

- (2) Dry contact specification: 1A@125VAC.

Function: The dry contact interface is connected with the generator switch to turn on/off the generator.

- (3) Connecting with the RS485 port, an optional WiFi, Bluetooth, TCP, or 4G module can remote control the inverter/charger. Pin definition for the RS485 port is the same as the BMS port, see description in above section (1).
- (4) Pin definition for the parallel connection interface:

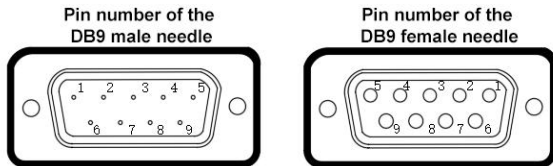

Pin	Definition	Pin	Definition
1	HFS-BUS	4	CAN-L
2	PFS-BUS	5	CAN-H
3	PS-GND	6/7/8/9	Reserved

1.3 Naming rules

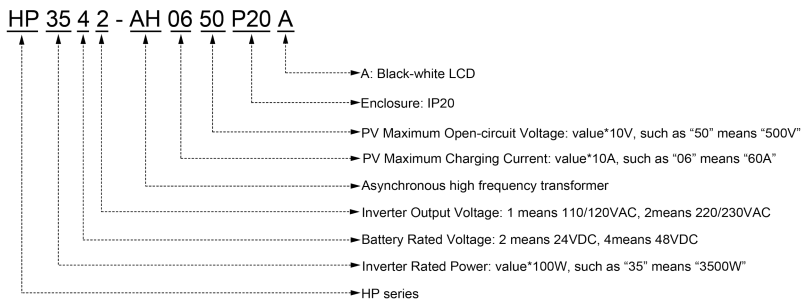

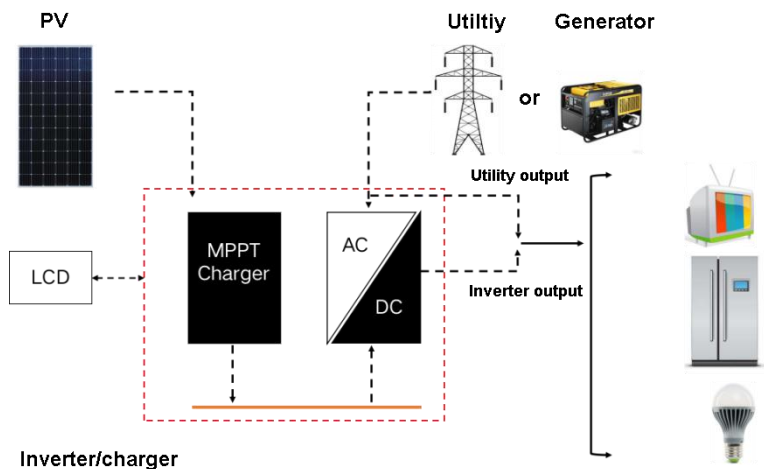

1.4 Connection diagram

- No battery mode

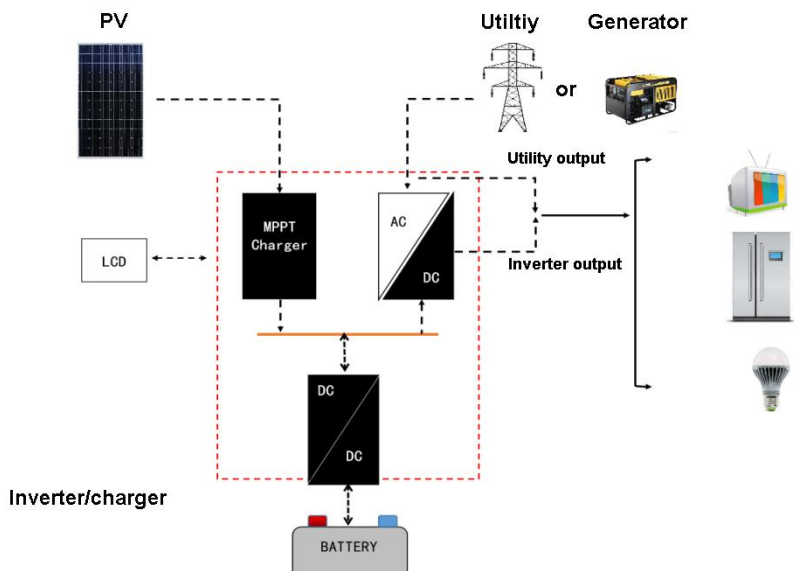

• **Battery mode**



 WARNING	<p>AC loads shall be determined according to the output power of the inverter/charger.</p> <p>The load exceeding the maximum output power may damage the inverter/charger.</p>
 CAUTION	<ul style="list-style-type: none"> • For different battery types, confirm the relevant parameters before power on. • There are many types of oil generators with complex output conditions, which must be tested before use. It is necessary to undergo on-site no-load trial operation testing to confirm that the voltage and frequency fluctuations are within the allowable range of the equipment before use.

2 Interface

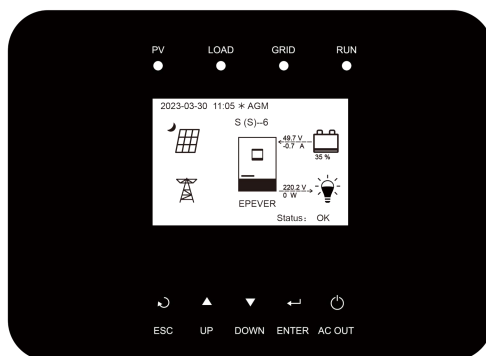





Note: The display screen can be viewed clearly when the angle between the end-user's horizontal sight and the display screen is within 90°. If the angle exceeds 90°, the information on the display screen cannot be viewed clearly.

2.1 Indicator







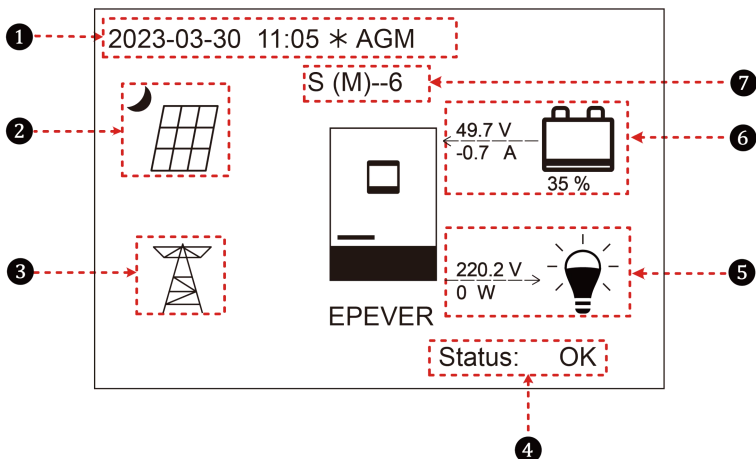

Indicator	Status	Instruction
PV	OFF	No PV input
	Green ON	PV normal
	Red ON	PV charging fault (PV1/PV2 over voltage)
LOAD	OFF	No inverter output
	Green ON	Inverter, charging, and bypass are normal
	Red ON	Inverter fault (inverter over current/over voltage/under voltage, output short-circuit, and over load)
GRID	OFF	No utility input
	Green ON	Utility normal
	Green flashing (1Hz)	Oil generator charging
	Red ON	Utility charging fault (Utility over voltage/ over current/under voltage/frequency abnormal)
RUN	Green flashing (1Hz)	Normal communication
	Red flashing (1Hz)	Communication fault

2.2 Buttons

Buttons	Operation	Instruction
	Click	<ul style="list-style-type: none"> Exit the current interface. Switch from the "home screen" to the "Main Table Data Information" screen.
	Click	<ul style="list-style-type: none"> Browse interface: Up/Down. Parameters setting interface: Increase or decrease the parameter value per step size.
	Press and hold	Parameters setting interface: Increase or decrease the parameter value per 10 times the step size.
	Click	<ul style="list-style-type: none"> Click on the Home screen to enter the real-time data screen Click on the parameter browse interface to enter the parameter setting interface. Confirm the setting parameters.
	Press and hold	Press and hold on the home screen to enter the password interface. After verifying the password, enter the parameter browse interface.
	Click	Click on the time or password setting interface to move the cursor left.
	Press and hold	Press and hold on the home screen to turn on/off the inverter output, the utility charging, or the utility bypass.

2.3 Home screen



No.	Instruction
1	Display the system time, current battery type, and charging stage. When the BMS communication is normal, the icon BMS will be shown on the far right, while when it is abnormal, the icon BMS will be shown on the same position.
2	<p>PV icon:  PV connection is normal.  No PV connection (or at night).</p> <p>Actual PV voltage / total PV power</p>
3	<p>Utility icon:  Utility connection is normal.  No utility connection.</p> <p>Utility input voltage / Utility input power</p>
4	<p>Status: When there are no faults, it displays "OK." When faults occur, it displays the minimum fault code.</p> <p>Note: On the home screen, click the "UP/DOWN" button to select the "Status" bar, and click the "ENTER" button to check the detailed fault.</p>
5	<p>Load icon:  AC output is normal.  No AC output.</p> <p>AC output voltage / AC output power</p>
6	<p>Battery status:  The battery is discharging.</p> <p> The battery is being charged.</p>

	Battery voltage / battery current / lithium battery real-time SOC (display "--" without lithium battery)
7	Parallel status icon. It shows when there is two or more inverterchargers connect in parallel successfully, and it will not display on the single inverter/charger.

★ When the PV array charges the battery, the equalizing charging is performed on the 28th of each month by default (the date can be modified).

- Parallel status icon name rule:

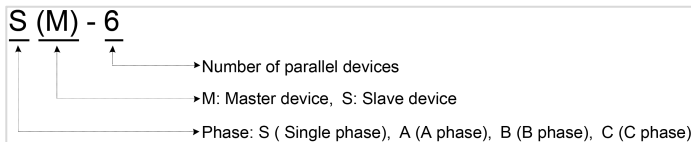

Note: The master and slave units are randomly defined.

2.4 Interface

2.4.1 Real-time data interface

After powering on the inverter/charger, the home screen shows up. Click the "ENTER" button to enter the real-time data screen. Click the "ENTER" button to enter the next real-time screen, click the "UP/DOWN" button to browse all parameters on current screen, or click the "ESC" button to return the home screen.

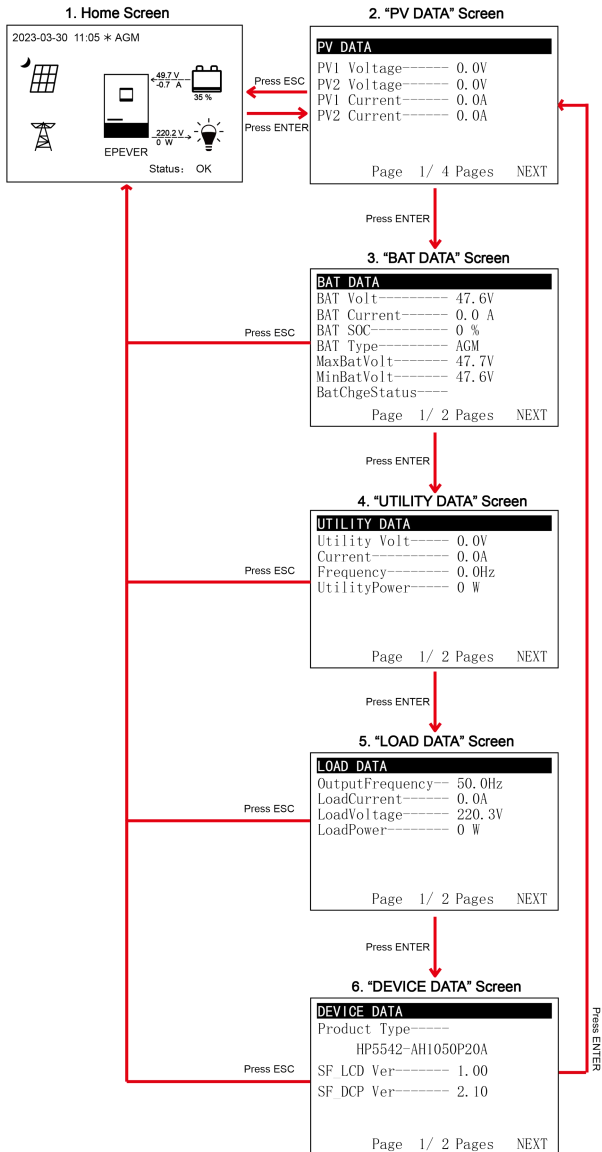

2.4.2 User interface

After powering on the inverter/charger, the home screen shows up. Click the "ESC" button to enter the "Main Table Data Information" screen. Click the "ENTER" button to enter the next interface, or click the "UP/DOWN" button to browse the current screen display.

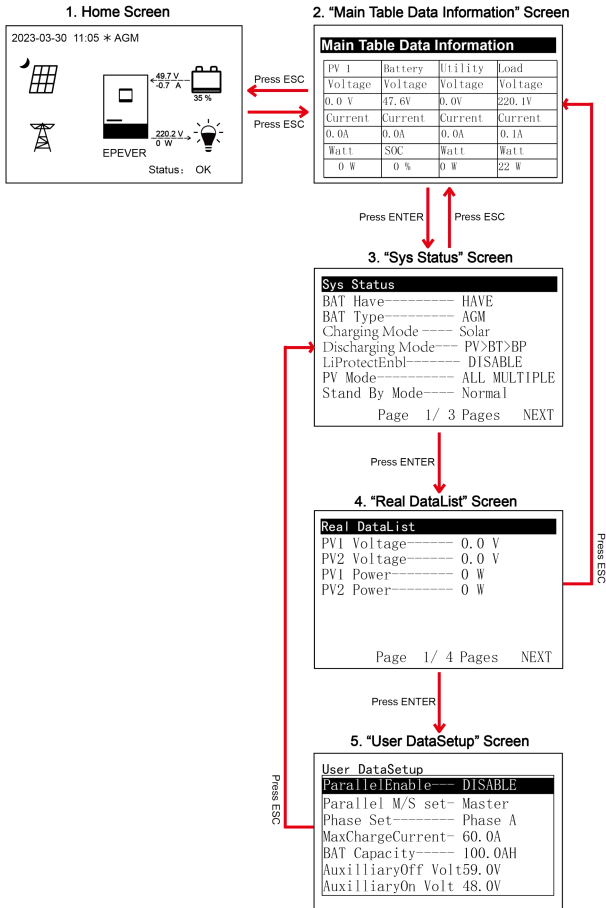

➤ "User Data Setup" interface

The end-users can modify common parameters on the "User Data Setup" interface without inputting the

password. The default parameters and setting range refer to chapter 2.5.1 Parameters list.

2.4.3 Administrator interface

After powering on the inverter/charger, the home screen shows up. Press and hold the "ENTER" button to enter the password interface. Input the password correctly (0000 by default) to check all parameters or modify them.

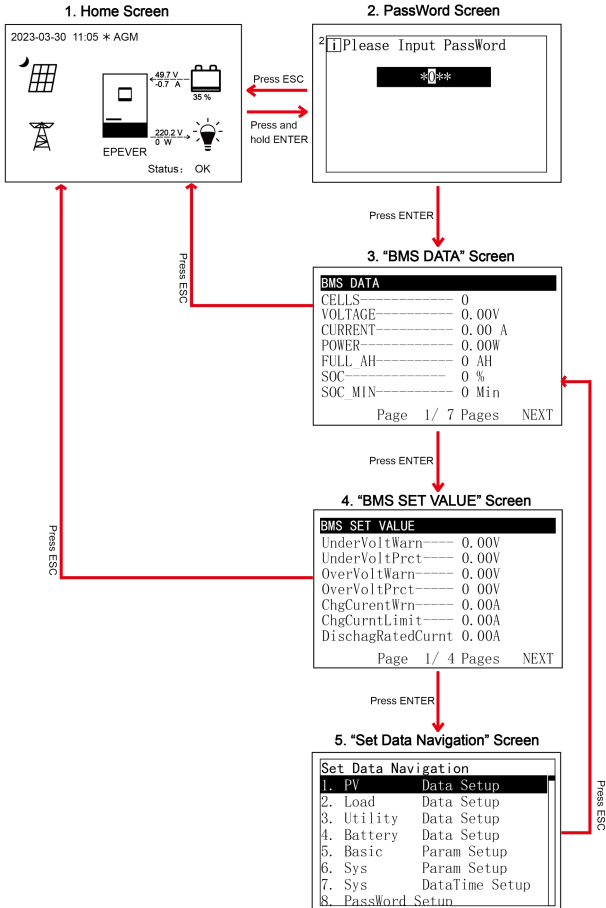

2.5 Parameters setting

2.5.1 Parameters list

Set Data Navigation	
1. PV	Data Setup
2. Load	Data Setup
3. Utility	Data Setup
4. Battery	Data Setup
5. Basic	Param Setup
6. Sys	Param Setup
7. Sys	DataTime Setup
8. PassWord	Setup

Enter the "Set Data Navigation" interface according to chapter [2.4.3 Administrator interface](#). Then click the "UP/DOWN" button to select navigation 1 – 9 for detail settings. Default parameters and setting ranges are shown in the following table.

Note: On the parameter setting interface, click the "UP/DOWN"

button to increase/decrease the parameter value by one step size (step size is the minimum unit to modify the parameter). Press and hold the "UP/DOWN" button to increase/decrease the parameter value by ten times the step size (Except for "BAT Capacity" and "Log Data Interval", these values will be increased/decreased by 100 times the step size). Press the "ENTER" button to confirm.

Parameters	Default	User define
1. PV Data Setup		
UnderVolProtect (PV Under Voltage Protect Voltage)	80.0V	User define: 80.0V to (PV Under Voltage Recover Voltage minus 5V), step size: 0.1V
UnderVoltRecover (PV Under Voltage Recover Voltage)	100.0V	User define: 100.0V to 200.0V, or (PV Under Voltage Protect Voltage plus 5V) to 200.0V, step size: 0.1V Note: Take the maximum value between 100.0V and (PV Under Voltage Protect Voltage plus 5V).
2. Load Data Setup		
OutputVoltLevel (Output voltage level)	220V	User define: 220V, 230V
OutputFrequency (Output Frequency)	50Hz	User define: 50Hz, 60Hz Note: When the Utility power is connected and the Utility frequency is detected, the output frequency will be in accordance with the Utility frequency in the Utility bypass mode. For single inverter/charger, it will take effect immediately after the output frequency is changed. For the parallel connection, you must shut down the inverter/charger for 10s and then restart it for the modification to take effect (Enter into the Load Data Setup page again to check if the change has been changed).

Parameters	Default	User define
UnbalanceSet (Current unbalance set)	DISABLE	User define: DISABLE, ENABLE Note: The parameter will only take effect when used in three phase. After restoring to factory settings, the default value is the last modified value.
Phase Set	Single	User define: Single, Phase A, Phase B, Phase C Note: After phase set is changed, must turn off the inverter charger for 10 seconds before restarting. Enter into the <u>Load Data Setup</u> page again to check if the change has taken effect. After restoring to factory settings, the default value is the last modified value.
UnbalanceValue (Current unbalance value)	5A	User define: 0A to 6000A, step size 1A Note: The parameter will only take effect when used in three phase. When “UnbalanSet” is enabled, if current unbalance value between any two phases is higher than set value, the load output will be turned off automatically. After restoring to factory settings, the default value is the last modified value.
3. Utility Data Setup		
OverVoltDisconnect (Utility over voltage disconnect voltage)	265.0V	User define:(Utility over voltage reconnect voltage plus 10V) to 285.0V, step size: 0.1V
OverVoltReconnect (Utility over voltage reconnect voltage)	255.0V	User define: 220.0V to (Utility over voltage disconnect voltage minus 10V), step size: 0.1V
Low Volt Disconct (Utility low voltage disconnect voltage)	175.0V	User define: 90.0V to (Utility low voltage reconnect voltage minus 10V), step size: 0.1V
LowVolt Reconnect (Utility low voltage reconnect voltage)	185.0V	User define: (Utility low voltage disconnect voltage plus 10V) to 220.0V, step size: 0.1V
OverFreqDisconnect (Utility over frequency disconnect)	70.0Hz	In the bypass state, when the actual utility input frequency is higher than this value, the inverter/charger will be switched to the inverter output state. User define: 52.0Hz to 70.0Hz, or (Utility under frequency disconnect plus 0.5Hz) to 70.0Hz, step size: 0.1Hz. Note: Take the maximum value between 52.0Hz and (Utility under frequency disconnect plus 0.5Hz).

Parameters	Default	User define
UnderFreqDisconct (Utility under frequency disconnect)	40.0Hz	In the bypass state, when the actual utility input frequency is lower than this value, the inverter/charger will be switched to the inverter output state. User define: 40.0Hz to 58.0Hz, or 40.0Hz to (Utility over frequency disconnect minus 0.5Hz), step size: 0.1Hz. Note: Take the minimum value between 58.0Hz and (Utility over frequency disconnect minus 0.5Hz).
MaxCharge Current (Max. Utility charging current)	60.0A	User define: 5.0A to 60.0A for HP3542-AH0650P20A, step size: 0.1A Namely, the maximum current at the battery end when the utility charges the battery.
	70.0A	User define: 5.0A to 70.0A for HP2022-AH0750P20A, step size: 0.1A Namely, the maximum current at the battery end when the utility charges the battery.
	100.0A	User define: 5.0A to 100.0A for HP5542-AH1050P20A, step size: 0.1A Namely, the maximum current at the battery end when the utility charges the battery.
	110.0A	User define: 5.0A to 110.0A for HP3522-AH1250P20A, step size: 0.1A Namely, the maximum current at the battery end when the utility charges the battery.
4. Battery Data Setup		
BAT Set Mode (Battery set mode)	Smart	User define: Smart (Refer to chapter 2.5.3), Expert (Refer to chapter 2.5.4)
BAT Capacity (Battery capacity)	100.0AH	User define: 10.0AH to 1200.0AH, step size: 0.1AH Note: When setting BAT Capacity, press and hold "UP/DOWN" button to increase/ decrease the value by 100*step size, namely, 10AH.
EqualizeTime (Battery equalize charging time)	120 Min	User define: 10 minutes to 180 minutes, step size: 1 minute
Boost Time (Battery boost charging time)	120 Min	User define: 10 minutes to 180 minutes, step size: 1 minute

Parameters	Default	User define
T/C mV/ °C /2 (Battery temperature compensate coefficient)	3	User define: 0—9, step size: 1 Note: This option is reserved, which is invalid currently.
AuxiliaryOff Volt (Auxiliary module Off voltage)	56.0V (48V system)	Under certain working modes, the utility will stop charging the battery if the battery voltage exceeds this value.
	28.0V (24V system)	User define: (Auxiliary module ON voltage plus (0.2*N)) ≤ Auxiliary module Off voltage ≤ Charging limit voltage (N=Rated battery voltage/12)
Auxiliary On Volt (Auxiliary module ON voltage)	51.0V (48V system)	Under certain working modes, the utility will charge the battery if the battery voltage is lower than this value.
	25.5V (24V system)	User define: Low voltage disconnect voltage ≤ Auxiliary module ON voltage ≤ (Auxiliary module Off voltage minus (0.2*N)) (N=Rated battery voltage/12)
MaxCharginCurrent (Battery Max. charging current)	60.0A	User define: 5.0A to 60.0A for HP3542-AH0650P20A, step size: 0.1A Namely, the maximum allowable charge current on the battery side.
	70.0A	User define: 5.0A to 70.0A for HP2022-AH0750P20A, step size: 0.1A Namely, the maximum allowable charge current on the battery side.
	100.0A	User define: 5.0A to 100.0A for HP5542-AH1050P20A, step size: 0.1A Namely, the maximum allowable charge current on the battery side.
	120.0A	User define: 5.0A to 120.0A for HP3522-AH1250P20A, step size: 0.1A Namely, the maximum allowable charge current on the battery side.

Parameters	Default	User define
LimitDisChgCurr (Battery limit discharging current)	175.0A	User define: 10.0A to 175.0A for HP3542-AH0650P20A, step size: 0.1A Namely, the maximum allowable discharge current on the battery side.
	220.0A	User define: 10.0A to 220.0A for HP2022-AH0750P20A, step size: 0.1A Namely, the maximum allowable discharge current on the battery side.
	250.0A	User define: 10.0A to 250.0A for HP5542-AH1050P20A, step size: 0.1A Namely, the maximum allowable discharge current on the battery side.
	380.0A	User define: 10.0A to 380.0A for HP3522-AH1250P20A, step size: 0.1A Namely, the maximum allowable discharge current on the battery side.
BMS ComStatus (BMS Communication Status)	164	Read-only, 164 indicates abnormal BMS communication, 165 indicates normal BMS communication.
ChargeControlMode (Battery charge control mode)	VOLT (Voltage)	User define: VOLT, SOC <u>VOLT</u> : The battery voltage control parameters take effect after setting this value as "VOLT." <u>SOC</u> : The SOC parameters take effect after setting this value as "SOC." Note: If "SOC" is selected, the battery needs to go through several full charge and discharge cycles, and the battery capacity must be set correctly.
BMS InvalidAction	DSP Auto	User define: DSP Auto, NoAction <u>DSP Auto</u> : The inverter/charger works according to the default mode and parameters. <u>NoAction</u> : No charging and discharging, equivalent to standby mode.

Parameters	Default	User define
Full Discnct Soc (Full energy disconnect Soc)	100%	It takes effect after the "ChargeControlMode" is set as "SOC." When the battery SOC is higher than or equals to this value, the inverter/charger will stop charging the battery. User define: (Full energy disconnect recover Soc plus 5%) to 100%, or 80% to 100%, step size: 1% Note: Take the maximum value between (Full energy disconnect recover Soc plus 5%) and 80%.
FulDiscnctRecvSoc (Full energy disconnect recover Soc)	95%	It takes effect after the "ChargeControlMode" is set as "SOC." When the battery SOC is lower than this value, the inverter/charger will charge the battery. User define: 60% to (Full energy disconnect Soc minus 5%), step size: 1%
LwEngyDisRecvrSoc (Low energy disconnect recover Soc)	40%	It cannot be set separately (equals the "LwEgyDnctRecvrSoc"). It takes effect after the "ChargeControlMode" is set as "SOC."
UnderEngyAlarmSoc (Under energy alarm Soc)	25%	It takes effect after the "ChargeControlMode" is set as "SOC." User define: 10% to 35%, or 10% to (Low energy disconnect recover Soc minus 5%), step size: 1% Note: Take the minimum value between (Low energy disconnect recover Soc minus 5%) and 35%.
LwEgyDnctRecvrSoc (Low energy disconnect recover Soc)	40%	It takes effect after the "ChargeControlMode" is set as "SOC." User define: (Under energy alarm Soc plus 5%) to 60%, or 20% to 60%, step size: 1% Note: Take the maximum value between (Under energy alarm Soc plus 5%) and 20%.
LowEngyDiscnctSoc (Low energy disconnect Soc)	10%	It takes effect after the "ChargeControlMode" is set as "SOC." When the battery SOC is lower than this value, the battery will stop discharging. User define: 0 to 10%, step size: 1%

Parameters	Default	User define
UtilityChargeOnSoc (Utility charging on Soc)	30%	It takes effect after the "ChargeControlMode" is set as "SOC." User define: 20% to 50%, or 20% to (Utility charging off Soc minus 10%), step size: 1% Note: Take the minimum value between 50% and (Utility charging off Soc minus 10%).
UtilityChargeOfSoc (Utility charging off Soc)	60%	It takes effect after the "ChargeControlMode" is set as "SOC." User define: (Utility charging on Soc plus 10%) to 100%, or 40% to 100%, step size: 1% Note: Take the maximum value between (Utility charging on Soc plus 10%) and 40%.
SOC BAT Capacity (SOC battery capacity)	Not fixed, updated in real time	Read-only (After the BMS is connected, this value will read from the BMS)
LimitChgTemp (Limit charge temperature)	0.0°C	User define: -20°C to 0°C, step size: 0.1°C When the environment or the battery temperature is lower than this value, the inverter/charger will stop charging the battery.
LimitDisChgTem (Limit discharge temperature)	0.0°C	User define: -20°C to 0°C, step size: 0.1°C When the environment or the battery temperature is lower than this value, the inverter/charger will stop discharging.
BATOverTemp (Battery over temperature protect)	50.0°C	User define: (Battery over temperature protect recover plus 5°C) to 60°C, step size: 0.1 °C
BATOverTempRecovr (Battery over temperature protect recover)	45.0°C	User define: 30 °C to (Battery over temperature protect minus 5°C), step size: 0.1 °C
Equalize Date	28	User define: 1—28, step size: 1
Manual Equalize	OFF	User define: OFF, ON This parameter is for manual equalizing charging. When set to "ON", the inverter/charger enters the manual equalizing charging working mode. After the inverter/charger restarts, the default value is restored to "OFF," indicating that the inverter/charger is charged periodically according to the set equalization charging cycle.

Parameters	Default	User define
ResetSocCalculate (Reset Soc calculate)	--	Press the ENTER button to reset, the SOC will be automatically recalculated.
ResetSelfStudyAH	--	Press the ENTER button to reset the self study AH.
5. Basic Param Setup		
BAT Have (Battery have or not)	HAVE	User define: HAVE, NO, REV Note: When the parameter value is changed (i.e., the value is changed from "HAVE" to "NO", or from "NO" to "HAVE"), the AC output will be cut off for about 3 seconds before resuming normal output.
Charging Mode	Utlyt&solr	User define: Solar, SolarPrior (Solar priority), Utlyt&solr (Utility & solar), UtlytPrior (Utility priority). Note: For detailed working modes, refer to chapter 4.
Discharging Mode	PV>BT>BP	User define: PV>BP>BT (namely, PV>Bypass>Battery), PV>BT>BP (namely, PV>Battery>Bypass), BP>PV>BT (namely, Bypass>PV>Battery). Note: For detailed working modes, refer to chapter 4.
LiProtectEnbl (Lithium battery protection enable)	DISABLE	User define: DISABLE, ENABLE Set this value as "ENABLE," the charge/ discharge low temperature limit function is effective.
PV Mode	ALL SINGLE	User define: ALL SINGLE, ALL MULTIPLE, When two PV arrays are independently input, the value shall be set to "ALL SINGLE." When two PV arrays are connected in parallel as a single input to the inverter/charger (the PV terminals need to be paralleled externally), the value needs to be set to "ALL MULTIPLE." Product with one PV input is "ALL SINGLE" by default (other PV modes are invalid).
Stand By Mode	Normal	User define: Normal, Standby When set as "Standby," the inverter charger will enter standby mode and the AC output will be stopped. After modifying the parameter and restarting the inverter/charger, the parameter will be restored to the default value (the previous modified value will not be saved).

Parameters	Default	User define
EqualizeEnable	DISABLE	User define: DISABLE, ENABLE This parameter is for automatic equalizing charging. Set this value as "ENABLE," the inverter/charger performs the equalize charging automatically. After modifying the parameter and restarting the inverter/charger, the parameter will be restored to the default value (the previous modified value will not be saved).
ECO Mode	ENABLE	User define: DISABLE, ENABLE When set as "ENABLE," the inverter/charger will enter the low power consumption mode when certain conditions are met, such as no PV and utility, and the battery voltage drops to the "Low voltage disconnect voltage." After modifying the parameter and restarting the inverter/charger, the parameter will be restored to the default value (the previous modified value will not be saved).
Calibration Mode	OFF	User define: OFF, ON Note: This option is reserved, which is invalid currently.
Return FactorySet (Return to the factory settings)	--	Factory Set (After setting the "Stand By Mode" as "Standby," some settings can be restored to the factory state.) Note: For other parameters, only the last modified values will be saved and cannot be restored to the factory state. Please refer to the parameter description for details. After setting, restart the inverter/charger for the setting to take effect.
FR (fault reset)	--	Press the "ENTER" button to exit the current fault state and resume normal operation. Note:The historical fault records will not be cleared.

Parameters	Default	User define
Load Open/Close	OPEN	User define: CLOSE, OPEN. Open or close the loads. This parameter and the load output switch are of the same control. To change the state of either one, the other will be changed too. After modifying the parameter and restarting the inverter/charger, the parameter will be restored to the default value (the previous modified value will not be saved).
PVDCInputSource	DISABLE	User define: DISABLE, ENABLE When using a DC power to replace the PV array for power supply testing, it is necessary to set the "PV DC Input Source" as "ENABLE." Otherwise, the inverter/charger cannot work properly. After modifying the parameter and restarting the inverter/charger, the parameter will be restored to the default value (the previous modified value will not be saved).
ClearAccum Energy (Clear accumulated energy)	--	Press the ENTER button to clear all accumulated charge and discharge energy.
DryContactOnVolt (Dry contact ON voltage)	44.0V (48V system)	User define: 0 to (Dry contact OFF voltage minus 0.1*N), step size: 0.1V. Note: N=Rated battery voltage/12.
	22.0V (24V system)	When the battery voltage is lower than this value, the dry contact is connected.
DryContactOfVolt (Dry contact OFF voltage)	50.0V (48V system)	User define: (Dry contact ON voltage plus 0.1*N) to Over voltage disconnect voltage, step size: 0.1V. Note: N=Rated battery voltage/12.
	25.0 (24V system)	When the battery voltage is higher than this value, the dry contact is disconnected.
AC Input mode	Grid	User define: Grid, Generator When the AC input is a generator, this parameter needs to be set to "Generator" to improve the charging capability. Note: If the AC input mode does not match the AC source of the actual input, the normal operation of the inverter/charger will be affected. After setting, restart the inverter/charger for the setting to take effect.

Parameters	Default	User define
BATT Input Mode	Shared	User define: Shared, Independent This parameter takes effect when the inverter/chargers are connected in parallel. If each inverter/charger is connected to the same battery pack, this value needs to be set to "Shared" mode. If each inverter/charger is connected to a separate battery pack, this value needs to be set to "Independent" mode.
6. Sys Param Setup		
BackLightTime	30S	User define: 6S, 30S, 60S, Always
BuzzerAlert	ON	User define: OFF, ON If set to "ON," the buzzer will sound when an error occurs and will keep silence when the error is cleared. If set to "OFF," the buzzer will not sound even if an error occurs.
BckLightOnOff (Back Light On/Off)	ON	User define: OFF, ON Note: "BckLightOnOff" is superior to "BackLightTime."
BaudRate	115200	User define: 115200, 9600, 19200, 38400, 57600
Address	1	User define: 1—254, step size: 1
Log Data Interval	60 Sec	User define: 1 second to 3600 seconds, step size: 1 second (Note: When setting this value, press and hold the "UP/DOWN" button to increase/decrease the value by 100*step size, namely, 100 seconds.) Set the time interval of the historical data (only refers to the voltage, current and other data stored regularly, excluding the historical faults. These historical data can be exported by the Solar Guardian PC software or Website.)
Language	ENGLISH	User define: ENGLISH, CHINESE
BlueValid	VALID	User define: INVALID, VALID. Note: This option is reserved, which is invalid currently.
Temperature Unit	°C	User define: °C, °F
BMS Valid/Invalid	INVALID	User define: INVALID, VALID Set this value as "VALID," the inverter/charger will communicate with the battery normally.

Parameters	Default	User define
BMS Protocol	0	User define: 0–240, step size: 1 Note: Refer to the Lithium battery protocol file.
BMS Com Method	RS485	Read-only
Led Switch	OPEN	User define: OPEN, CLOSE Turn on/off the PV/LOAD/GRID/RUN indicators.
BMSVltCntrlEnable (BMS voltage control enable)	DISABLE	User define: DISABLE, ENABLE Set this value as "ENABLE," the BMS internal control parameters will be automatically synchronized to the inverter/charger, and the inverter/charger will control the battery charging/discharging based on these parameters.
BMSCurent Select (BMS current control select) (See chapter 2.5.2 Battery work modes for details)	INVALID	User define: INVALID, BMS, VIRTUAL_BMS Set this value as "INVALID," the inverter/charger controls the charge and discharge according to the value set on the LCD. Set this value as "BMS," the inverter/charger controls the charge and discharge according to the read BMS value. Set this value as "VIRTUAL_BMS", the inverter/charger controls the charge and discharge according to the charge-discharge current value calculated by the MAP table, which is preset in the inverter/charger.
Log Data Reset	--	Press the ENTER button to clear the voltage, current and other data stored regularly, excluding the historical faults. Note: After pressing the ENTER button, the flashing LED light will become steady or turn off, and then the inverter/charger will restart, indicating that the reset is complete.
BATT Discharge Kx (Batory charge and discharge coefficient)	3C	User define: 1C, 3C This value can be obtained by viewing the battery label. It takes effect only when the "BMSCurrent Select" is set as "VIRTUAL_BMS." When this parameter is set to "3C," the inverter/charger controls the charge and discharge according to the minimum value between 3 x BAT Capacity and MaxCharginCurrent/ LimitDisChgCurr (which are set on the LCD).

Parameters	Default	User define
MAP TEMP Select (MAP temperature select)	Default	<p>User define: Default (25 °C), BMS_ET (BMS environment temperature), BMS_C_MaxT (BMS cell maximum temperature), BMS_C_MinT (BMS cell minimum temperature), RS485, DSP</p> <p>The MAP table calculates the charging and discharging current values based on the temperature and SOC value of the lithium battery.</p> <p>When the lithium battery has BMS function and supports temperature upload, set "MAP TEMP Select" as "BMS_ET, BMS_C_MaxT, or BMS_C_MinT" according to the uploaded temperature. The "BMS_ET, BMS_C_MaxT, and BMS_C_MinT" take effect only when the "BMS_Curent Select" is set as "VIRTUAL_BMS."</p> <p>When the lithium battery only has a protection board, set "MAP TEMP Select" as "RS485" (A smart remote temperature sensor is needed). Otherwise; select "default (25°C)."</p> <p>"DSP" means the inverter/charger's temperature by default.</p>
ManualChageEnable (Manual charge enable)	ENABLE	<p>User define: ENABLE, DISABLE</p> <p>Under the normal BMS communication, if the "ManualChageEnable" is set to "ENABLE," the lithium battery charging is allowed. If the "ManualChageEnable" is set to "DISABLE," the lithium battery charging is not allowed.</p>
7. Sys DateTime Setup (See chapter 2.5.5)		
8. Password Setup (See chapter 2.5.6)		
9. Bat Control Data Setup (This will take effect when setting the "BAT Set Mode" as "Smart.")		
BAT Set Mode (Battery set mode)	Smart	Read-only
Level	48V (48V system)	Read-only
	24V (24V system)	
Battery Type	AGM	48V battery type: AGM, GEL, FLD, LFP15S, LFP16S, LNCM13S, LNCM14S
		24V battery type: AGM, GEL, FLD, LFP8S, LNCM6S, LNCM7S

Parameters	Default	User define
BoostCharginVolt (Boost charging voltage)	57.6V (48V system)	Read-only Note: They are determined by the battery type and cannot be modified.
	28.8V (24V system)	
FloatChagingVolt (Float charging voltage)	55.2V (48V system)	
	27.6V (24V system)	
LowVoltReconnect (Low voltage reconnect voltage)	50.0V (48V system)	
	25.0V (24V system)	
LowVoltDisconnect (Low voltage disconnect voltage)	43.2V (48V system)	
	21.6V (24V system)	
9. Bat Control Data Setup (This will take effect when setting the "BAT Set Mode" as "Expert" first)		
BAT Set Mode (Battery set mode)	Expert	Read-only
Level	48V (48V system)	Read-only
	24V (24V system)	
Battery Type	AGM	48V battery type: AGM, GEL, FLD, LFP15S, LFP16S, LNCM13S, LNCM14S
		24V battery type: AGM, GEL, FLD, LFP8S, LNCM6S, LNCM7S
OverVoltDiscnect (Over voltage disconnect voltage)	64.0V (48V system)	User define: Charging limit voltage< Over voltage disconnect voltage≤ 16*N, step size: 0.1V Note: N=Rated battery voltage/12.
	32.0V (24V system)	
ChargingLimitVolt (Charging limit voltage)	60.0V (48V system)	User define: Equalize charging voltage< Charging limit voltage< Over voltage disconnect voltage, step size: 0.1V
	30.0V (24V system)	
OverVoltReconnect (Over voltage reconnect voltage)	60.0V (48V system)	User define: 9*N≤ Over voltage reconnect voltage< (Over voltage disconnect voltage minus 0.1*N), step size: 0.1V. Note: N=Rated battery voltage/12.
	30.0V (24V system)	
EqualizeChagVolt (Equalize charging voltage)	58.4V (48V system)	User define: Boost charging voltage≤ Equalize charging voltage≤ Charging limit voltage, step size: 0.1V
	29.2V (24V system)	
BoostCharginVolt (Boost charging voltage)	57.6V (48V system)	User define: Float charging voltage≤ Boost charging voltage≤ Equalize charging voltage, step size: 0.1V
	28.8V (24V system)	
FloatChagingVolt (Float charging voltage)	55.2V (48V system)	User define: Boost voltage reconnect voltage< Float charging voltage≤ Boost charging voltage, step size: 0.1V
	27.6V (24V system)	

Parameters	Default	User define
BoostReconnectVolt (Boost voltage reconnect voltage)	52.8V (48V system)	User define: Low voltage reconnect voltage< Boost voltage reconnect voltage< Float charging voltage, step size: 0.1V
	26.4V (24V system)	
LowVoltReconnect (Low voltage reconnect voltage)	50.0V (48V system)	User define: Low voltage disconnect voltage< Low voltage reconnect voltage< Boost voltage reconnect voltage, step size: 0.1V
	25.0V (24V system)	
UndrVltWarnRecvr (Under voltage warning recover voltage)	48.8V (48V system)	User define: (Under voltage warning voltage plus 0.1*N)< Under voltage warning recover voltage≤ Low voltage reconnect voltage, step size: 0.1V Note: N=Rated battery voltage/12.
	24.4V (24V system)	
UnderVolt Warn (Under voltage warning voltage)	48.0V (48V system)	User define: Discharging limit voltage≤ Under voltage warning voltage< (Under voltage warning recover voltage minus 0.1*N), step size: 0.1V Note: N=Rated battery voltage/12.
	24.0V (24V system)	
LowVoltDisconnect (Low voltage disconnect voltage)	43.2V (48V system)	User define: Discharging limit voltage≤ Low voltage disconnect voltage< Low voltage reconnect voltage, step size: 0.1V
	21.6V (24V system)	
DischrgeLimitVolt (Discharging limit voltage)	42.4V (48V system)	Read-only
	21.2V (24V system)	

Note: Except for some parameters (such as “OutputFrequency, Phase Set, Return FactorySet, and AC Input mode” for the parallel connection etc.), the inverter/charger needs to be restarted to take effect. The rest of the parameters take effect immediately after modifying.

2.5.2 Battery work modes

The following table lists the recommended working mode and setting process for different application scenarios. According to your current battery status (such as whether it is a lithium-ion battery pack, whether it has BMS function, whether it has current control function at the end of charge and discharge, etc.), you can reasonably set the parameters to ensure that the battery works in the optimal performance, so as to ensure the safe operation of the system for a long time.

No.	Scenario	Recommended work Mode	Setting Process
1	Non-lithium battery pack	The inverter/charger controls charging and discharging based on the LCD settings.	See Figure 1 "Setting process for non-lithium battery pack "
2	1. Lithium battery pack with BMS and current control function at the end of charge and discharge 2. Normal communication	The inverter/charger controls charging and discharging based on the read BMS values.	See Figure 2 "Setting process for lithium battery pack with BMS and current control function"
3	1. Lithium battery pack with BMS, without current control function at the end of charge and discharge 2. Normal communication	The inverter/charger controls charging and discharging based on the pre-set MAP table.	See Figure 3 "Setting process for lithium battery pack with BMS, without current control function"
4	1. Lithium battery pack with protective board only (no BMS) 2. No communication (A smart remote temperature sensor is recommended in this scenario.)	The inverter/charger controls charging and discharging based on the pre-set MAP table.	See Figure 4 "Setting process for lithium battery pack with protective board only"

● **Figure 1 "Setting process for non-lithium battery pack"**

When the system adopts non-lithium battery packs (such as AGM, GEL, or FLD batteries), follow the flowchart below to set parameters correctly. Set "BAT Capacity, T/C mV/°C/2, Battery Type" correctly, and set "ChargeControlMode" as "VOLT" or "SOC." And then set the battery voltage control parameters or SOC control parameters. The inverter/charger will control charging and discharging based on the LCD settings.

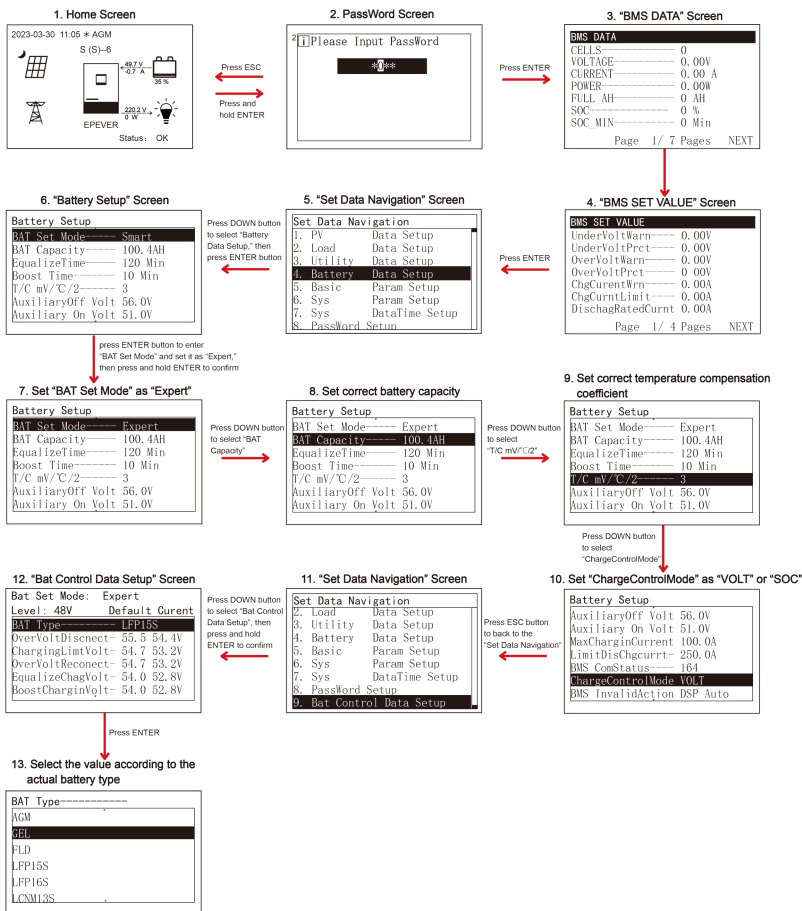

● Figure 2 "Setting process for lithium battery pack with BMS and current control function"

When the system adopts a lithium battery pack with BMS and current control function at the end of charge and discharge, and the lithium battery pack can communicate with the inverter/charger normally, follow the flowchart below to set parameters correctly. Set BMS protocol correctly, set "BMS Valid/Invalid" as "VALID," set "BMSVItCntrlEnable" as "ENABLE," set "BMSCurrent Select" as "BMS," and set "ChargeControlMode" as "VOLT" or "SOC." And then set the battery voltage control parameters or SOC

control parameters. The inverter/charger controls charging and discharging based on the read BMS values.

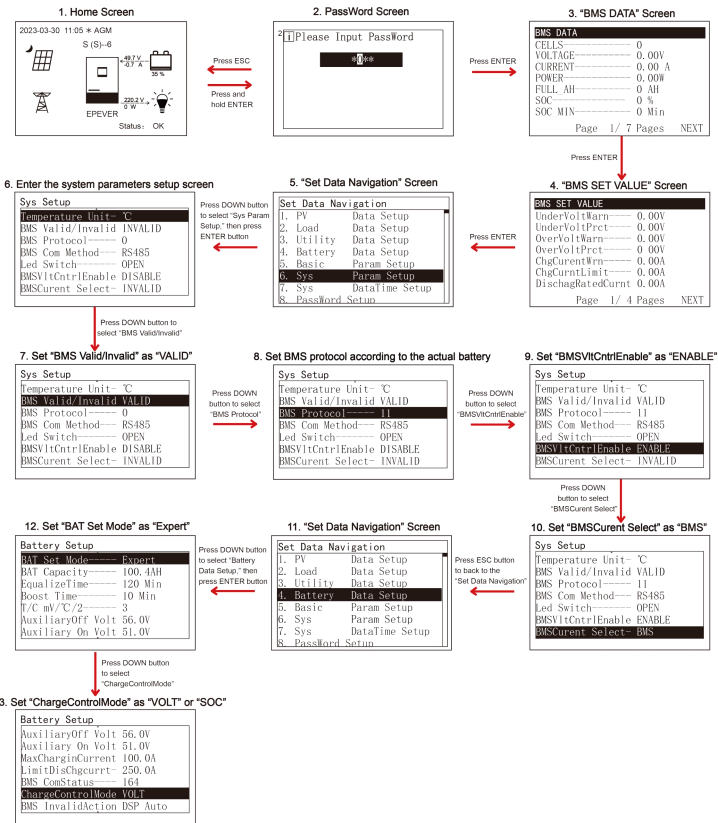

<p>Tip</p>	<p>Please go to EPEVER official website to download the currently supported BMS manufacturers and the BMS parameters.</p>
<p>CAUTION</p> 	<ul style="list-style-type: none"> • The inverter/charger will control charging and discharging based on the LCD settings after setting the "BMSCurrent Select" as "INVALID," or the communication between battery and inverter/charger fails. • The inverter/charger controls charging and discharging based on the pre-set MAP table after setting the "BMSCurrent Select" as "VIRTUAL_BMS."

	<ul style="list-style-type: none"> ● Due to the different charging and discharging characteristics and voltage consistency of lithium batteries from different manufacturers, it is necessary for professionals to guide the use of VIRTUAL_BMS for charging and discharging.
--	--

● **Figure 3 “Setting process for lithium battery pack with BMS, without current control function”**

When the system adopts a lithium battery pack with BMS, while without current control function at the end of charge and discharge, and the lithium battery pack can communicate with the inverter/charger normally, follow the flowchart below to set parameters correctly. Set BMS protocol and “BATT Discharge Kx” (viewing the battery label) correctly, set “BMS Valid/Invalid” as “VALID,” set “BMSVltCntrlEnable” as “ENABLE,” set “BMSCurent Select” as “VIRTUAL_BMS,” set “MAP TEMP Select” as “BMS_ET,” set “Battery Type” correctly, and set “ChargeControlMode” as “VOLT” or “SOC.” And then set the battery voltage control parameters or SOC control parameters. The inverter/charger controls charging and discharging based on the pre-set MAP table.

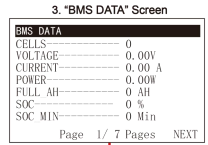
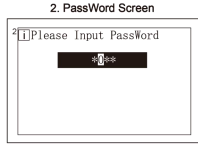
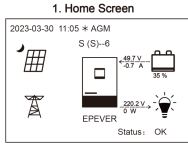

6. Enter the system parameters setup screen

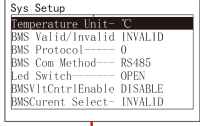

5. "Set Data Navigation" Screen

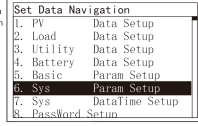

4. "BMS SET VALUE" Screen

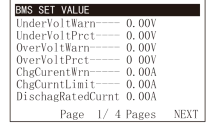

Press DOWN button to select "BMS Valid/Invalid"

Press DOWN button to select "Sys Param Setup", then press ENTER button

Press ENTER

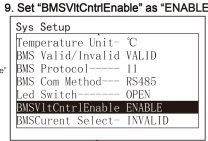
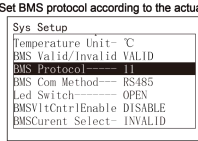
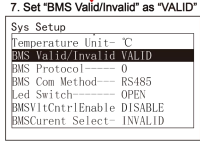

Press DOWN button to select "BMS Valid/Invalid"

Press DOWN button to select "BMS Protocol"

Press DOWN button to select "BMSVltCtrlEnable"

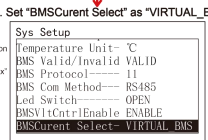
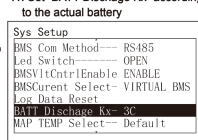
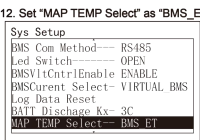

Press ESC button to back to the "Set Data Navigation"

Press DOWN button to select "MAP TEMP Select"

Press DOWN button to select "BMSCurrent Select"

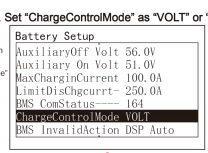
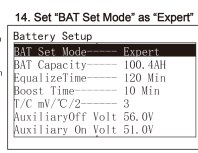
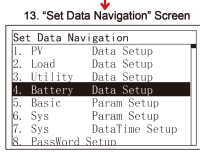

Press DOWN button to select "Battery Data Setup", then press ENTER button

Press DOWN button to select "BAT Set Mode"

Press DOWN button to select "ChargeControlMode"

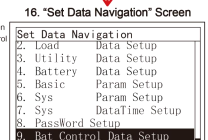
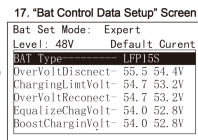
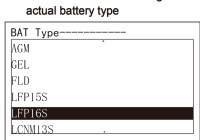

Press ENTER button to enter the battery type screen

Press DOWN button to select "Bat Control Data Setup", then press and hold ENTER to confirm

Press ESC button to back to the "Set Data Navigation"

 CAUTION	<ul style="list-style-type: none"> ● The inverter/charger will control charging and discharging based on the LCD settings after setting the "BMSCurent Select" as "INVALID." ● Due to the different charging and discharging characteristics and voltage consistency of lithium batteries from different manufacturers, it is necessary for professionals to guide the use of VIRTUAL_BMS for charging and discharging. ● The MAP table controlling the battery charge and discharge is only related to parameters of "BMSCurent Select, BATT Discharge Kx, Battery Type, and MAP TEMP Select."
---	--

● **Figure 4 "Setting process for lithium battery pack with protective board only"**

When the system adopts a lithium battery pack with protective board only, and the lithium battery pack cannot communicate with the inverter/charger normally (A smart remote temperature sensor is recommended in this scenario. Reserved function, this product is under development.), follow the flowchart below to set parameters correctly. Set "BATT Discharge Kx" (viewing the battery label) correctly, set "BMSCurent Select" as "VIRTUAL_BMS," set "MAP TEMP Select" as "RS485" (A smart remote temperature sensor is needed. Otherwise; select "default (25°C)."), set "Battery Type" correctly, and set "ChargeControlMode" as "VOLT" or "SOC." And then set the battery voltage control parameters or SOC control parameters. The inverter/charger controls charging and discharging based on the pre-set MAP table.

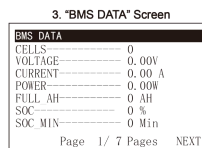
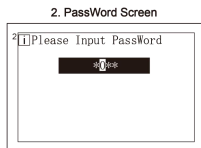
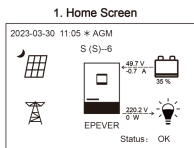

6. Enter the system parameters setup screen

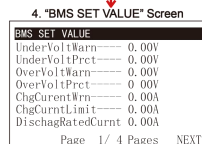
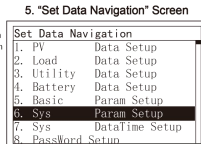
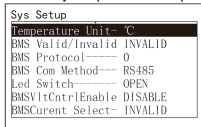

7. Set "BMSCurrent Select" as "VIRTUAL_BMS"

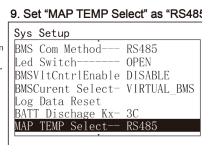
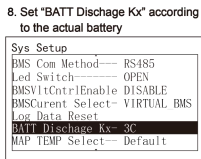
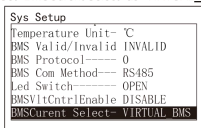

12. Set "ChargeControlMode" as "VOLT" or "SOC"

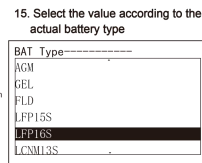
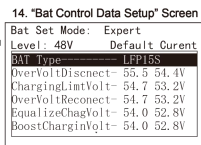
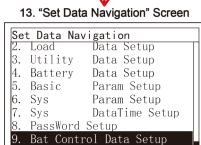
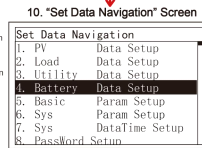
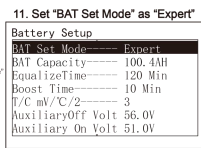
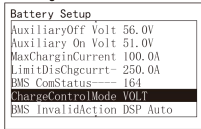

- The inverter/charger will control charging and discharging based on the LCD settings after setting the "BMSCurrent Select" as "INVALID."
- Due to the different charging and discharging characteristics and voltage consistency of lithium batteries from different manufacturers, it is necessary for professionals to guide the use of VIRTUAL_BMS for charging and discharging.
- The MAP table controlling the battery charge and discharge is only related to parameters of "BMSCurrent Select, BATT Discharge Kx, Battery Type, and MAP TEMP Select."

2.5.3 Battery voltage control parameters (Smart)

After setting the "BAT Set Mode" as "Smart," the battery voltage control parameters are determined by the battery type and cannot be modified. To modify them, set the "BAT Set Mode" as "Expert" first.

2.5.4 Battery voltage control parameters (Expert)

After setting the "BAT Set Mode" as "Expert," all battery voltage control parameters can be modified.

1) Lead-acid battery voltage control parameters

The parameters are measured in the condition of 24V/25°C.

Voltage control parameters	Battery Type			
	AGM	GEL	FLD	User define
Over Voltage Disconnect Voltage	32.0V	32.0V	32.0V	21.5–32V
Charging limit voltage	30.0V	30.0V	30.0V	21.5–32V
Over Voltage Reconnect Voltage	30.0V	30.0V	30.0V	21.5–32V
Equalize Charging Voltage	29.2V	--	29.6V	21.5–32V
Boost Charging Voltage	28.8V	28.4V	29.2V	21.5–32V
Float Charging Voltage	27.6V	27.6V	27.6V	21.5–32V
Boost Voltage Reconnect Voltage	26.4V	26.4V	26.4V	21.5–32V
Low Voltage Reconnect Voltage	25.0V	25.0V	25.0V	21.5–32V
Under Voltage Warning Recover Voltage	24.4V	24.4V	24.4V	21.5–32V
Under Voltage Warning Voltage	24.0V	24.0V	24.0V	21.5–32V
Low Voltage Disconnect Voltage	21.6V	21.6V	21.6V	21.5–32V
Discharging Limit Voltage	21.2V	21.2V	21.2V	Read-only

The parameters are measured in the condition of 48V/25°C.

Voltage control parameters	Battery Type			
	AGM	GEL	FLD	User define
Over Voltage Disconnect Voltage	64.0V	64.0V	64.0V	42.8–64V
Charging limit voltage	60.0V	60.0V	60.0V	42.8–64V
Over Voltage Reconnect Voltage	60.0V	60.0V	60.0V	42.8–64V
Equalize Charging Voltage	58.4V	--	59.2V	42.8–64V
Boost Charging Voltage	57.6V	56.8V	58.4V	42.8–64V
Float Charging Voltage	55.2V	55.2V	55.2V	42.8–64V
Boost Voltage Reconnect Voltage	52.8V	52.8V	52.8V	42.8–64V
Low Voltage Reconnect Voltage	50.0V	50.0V	50.0V	42.8–64V
Under Voltage Warning Recover Voltage	48.8V	48.8V	48.8V	42.8–64V
Under Voltage Warning Voltage	48.0V	48.0V	48.0V	42.8–64V

Low Voltage Disconnect Voltage	43.2V	43.2V	43.2V	42.8–64V
Discharging Limit Voltage	42.4V	42.4V	42.4V	Read-only

The following rules must be obeyed when setting the Lead-acid battery voltage control parameters.

- A. Over Voltage Disconnect Voltage > Charging Limit Voltage ≥ Equalize Charging Voltage ≥ Boost Charging Voltage ≥ Float Charging Voltage > Boost Voltage Reconnect Voltage
- B. Over Voltage Disconnect Voltage > Over Voltage Reconnect Voltage
- C. Low Voltage Reconnect Voltage > Low Voltage Disconnect Voltage ≥ Discharging Limit Voltage
- D. Under Voltage Warning Recover Voltage > Under Voltage Warning Voltage ≥ Discharging Limit Voltage
- E. Boost Voltage Reconnect Voltage > Low Voltage Reconnect Voltage

2) Lithium battery voltage control parameters

Voltage control parameters	Battery Type	LFP	
		LFP8S	User Define
Over Voltage Disconnect Voltage		29.6V	21.5–32V
Charging Limit Voltage		29.2V	21.5–32V
Over Voltage Reconnect Voltage		29.2V	21.5–32V
Equalize Charging Voltage		28.5V	21.5–32V
Boost Charging Voltage		28.5V	21.5–32V
Float Charging Voltage		27.2V	21.5–32V
Boost Voltage Reconnect Voltage		26.6V	21.5–32V
Low Voltage Reconnect Voltage		26.0V	21.5–32V
Under Voltage Warning Recover Voltage		25.6V	21.5–32V
Under Voltage Warning Voltage		24.8V	21.5–32V
Low Voltage Disconnect Voltage		23.2V	21.5–32V
Discharging Limit Voltage		22.0V	Read-only

Voltage control parameters	Battery Type	LFP		
		LFP15S	LFP16S	User Define
Over Voltage Disconnect Voltage		55.5V	59.2V	42.8–64V
Charging Limit Voltage		54.7V	58.4V	42.8–64V
Over Voltage Reconnect Voltage		54.7V	58.4V	42.8–64V
Equalize Charging Voltage		53.5V	57.1V	42.8–64V
Boost Charging Voltage		53.5V	57.1V	42.8–64V
Float Charging Voltage		51.0V	54.4V	42.8–64V
Boost Voltage Reconnect Voltage		49.9V	53.2V	42.8–64V

Low Voltage Reconnect Voltage	48.7V	52.0V	42.8–64V
Under Voltage Warning Recover Voltage	48.0V	51.2V	42.8–64V
Under Voltage Warning Voltage	46.5V	49.6V	42.8–64V
Low Voltage Disconnect Voltage	43.5V	46.4V	42.8–64V
Discharging Limit Voltage	41.2V	44.0V	Read-only

Voltage control parameters	LNCM		
	LNCM6S	LNCM7S	User Define
Over Voltage Disconnect Voltage	25.8V	30.1V	21.5–32V
Charging Limit Voltage	25.5V	29.8V	21.5–32V
Over Voltage Reconnect Voltage	25.5V	29.8V	21.5–32V
Equalize Charging Voltage	24.8V	28.9V	21.5–32V
Boost Charging Voltage	24.8V	28.9V	21.5–32V
Float Charging Voltage	24.0V	28.0V	21.5–32V
Boost Voltage Reconnect Voltage	23.5V	27.5V	21.5–32V
Low Voltage Reconnect Voltage	22.2V	25.9V	21.5–32V
Under Voltage Warning Recover Voltage	21.6V	25.2V	21.5–32V
Under Voltage Warning Voltage	21.0V	24.5V	21.5–32V
Low Voltage Disconnect Voltage	21.5V	22.4V	21.5–32V
Discharging Limit Voltage	18.6V	21.7V	Read-only

Voltage control parameters	LNCM		
	LNCM13S	LNCM14S	User Define
Over Voltage Disconnect Voltage	55.9V	60.2V	42.8–64V
Charging Limit Voltage	55.2V	59.5V	42.8–64V
Over Voltage Reconnect Voltage	55.2V	59.5V	42.8–64V
Equalize Charging Voltage	53.8V	57.9V	42.8–64V
Boost Charging Voltage	53.8V	57.9V	42.8–64V
Float Charging Voltage	52.0V	56.0V	42.8–64V
Boost Voltage Reconnect Voltage	51.0V	55.0V	42.8–64V
Low Voltage Reconnect Voltage	48.1V	51.8V	42.8–64V
Under Voltage Warning Recover Voltage	46.8V	50.4V	42.8–64V
Under Voltage Warning Voltage	45.5V	49.0V	42.8–64V
Low Voltage Disconnect Voltage	42.8V	44.8V	42.8–64V
Discharging Limit Voltage	40.3V	43.4V	Read-only

When setting the Lithium battery voltage control parameters, the following rules must be obeyed.

- A. Over Voltage Disconnect Voltage < Over Charging Protection Voltage (BMS Circuit Protection Modules)-0.2V
- B. Over Voltage Disconnect Voltage > Charging Limit Voltage ≥ Equalize Charging Voltage ≥ Boost Charging Voltage ≥ Float Charging Voltage > Boost Voltage Reconnect Voltage
- C. Over Voltage Disconnect Voltage > Over Voltage Reconnect Voltage
- D. Boost Voltage Reconnect Voltage > Low Voltage Reconnect Voltage > Low Voltage Disconnect Voltage ≥ Discharging Limit Voltage
- E. Under Voltage Warning Recover Voltage > Under Voltage Warning Voltage ≥ Discharging Limit Voltage
- F. Low Voltage Disconnect Voltage ≥ Over Discharging Protection Voltage (BMS Circuit Protection Modules) plus 0.2V

 CAUTION	The BMS circuit protection module's voltage control accuracy must be at least ±0.2V. The [Over Voltage Disconnect Voltage] shall be lower than the protection voltage of the BMS circuit protection module. In contrast, the [Low Voltage Disconnect Voltage] shall be higher. The increased voltage of the [Over Voltage Disconnect Voltage] and the [Low Voltage Disconnect Voltage] is determined by the control accuracy of the BMS circuit protection module.
---	--

2.5.5 Time setting

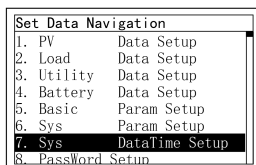

Enter the "Set Data Navigation" interface according to chapter [2.4.3 Administrator interface](#). Then click the "UP/DOWN" button to select "7 Sys Data Time Setup", and click the "ENTER" button to enter the system time setting interface. On the system time setting interface, click the "ENTER" button to move right, click the "AC OUT" button to move left, and click the "UP/DOWN" button to adjust the value. After the time setting is completed, move the cursor back to the first digit and click the "ENTER" to confirm. The system time will be updated if the setting value complies with the range.

2.5.6 Password modifying

Set Data Navigation	
1. PV	Data Setup
2. Load	Data Setup
3. Utility	Data Setup
4. Battery	Data Setup
5. Basic	Param Setup
6. Sys	Param Setup
7. Sys	DataTime Setup
8. Password Setup	

Enter the "Set Data Navigation" interface according to chapter [2.4.3 Administrator interface](#). Then click the "UP/DOWN" button to select "8 PassWord Setup", and click the "ENTER" button to enter the password modifying interface. Click the "ENTER" button to move right, click the "AC OUT" button to move left, and click the "UP/DOWN" button to adjust the value. After the password is modified, move the cursor back to the first digit and click the "ENTER" button to confirm.

Note: The default password is "0000", which is set to prevent non-professional operations. Please memorize the new password after modifying it. If forgetting the password, press and hold the "AC OUT" button on the password inputting page; the password will be automatically reset to "0000."

3 Single Installation

3.1 Attention

- Please read the manual carefully to familiarize yourself with the installation steps.
- Be very careful when installing the batteries, especially flooded lead-acid batteries. Please wear eye protection, and have fresh water available to rinse if contact with battery acid.
- Keep the battery away from any metal objects, which may cause a short circuit of the battery.
- Combustible and harmful gases may come out from the battery during charging. Ensure the ventilation condition is good.
- This inverter/charger is wall-mounted. Consider whether the wall's bearing capacity can meet the requirements.
- Ventilation is highly recommended if mounted in an enclosure. Never install the inverter/charger in a sealed enclosure with flooded batteries! Battery fumes from vented batteries will corrode and destroy the inverter/charger circuits.
- The inverter/charger can work with lead-acid and lithium batteries within its control scope.
- Ensure all switches and breakers are disconnected before wiring. You operate the inverter/charger after checking that all wiring is correct.
- Loose connections and corroded wires may produce high heat that can melt wire insulation, burn surrounding materials, or even cause a fire. Ensure tight connections, use cable clamps to secure cables, and prevent them from swaying in motion.
- Select the system connection cables according to the current density no greater than $5A/mm^2$.
- The inverter/charger is for indoor installation only. Do not install the inverter/charger in a harsh environment such as humid, salt spray, corrosion, greasy, flammable, explosive, or dust accumulative.
- After turning off the switch, high voltage still exists inside the inverter/charger. Do not open or touch the internal devices; wait ten minutes before conducting related operations.
- Although the DC input terminal has reverse polarity protection, which only take effect without PV and Utility connection; please do not operate it in error frequently.
- The inverter/charger has anti-reverse protection circuit at the PV input terminal.



CAUTION

1. The short-circuit current of the PV array must comply with the "PV Maximum Short-circuit Current" in chapter [8 Specifications](#). The reverse connection time should not exceed 5 minutes, avoid frequent operations in fault.

2. The PV array must first be connected to a 500VDC or above circuit breaker with arc extinguishing function, and then connected to the inverter/charger. If the PV is reversed, disconnect the external circuit breaker first, and then disconnect the PV array terminal (such as the MC4 terminal) or the PV input terminal of the inverter/charger. Otherwise, an electric arc will be generated, causing damage to the PV array or the inverter/charger.

- Utility input and AC output are high voltage. Please do not touch the wiring connection.
- When the fan is working, please do not touch it to avoid injury.

3.2 Wire and breaker size

The wiring and installation methods must conform to all national and local electrical code requirements.

➤ Recommended PV wire and breaker size

Since the PV output current varies with the PV module's size, connection method, or sunlight angle, the minimum wire size can be calculated by the PV I_{sc} (Max. short circuit current). Please refer to the I_{sc} value in the PV module's specifications. When the PV modules are connected in series, the total I_{sc} equals any PV module's I_{sc}. When the PV modules are connected in parallel, the total I_{sc} equals the sum of the PV module's I_{sc}. The PV array's I_{sc} must not exceed the maximum PV input current. For max. PV input current and max. PV wire size, please refer to the table below:

Model	PV wire size	Circuit breaker
HP2022-AH0750P20A	3.1 mm ² /12AWG	2P—16A (with arc extinguishing function)
HP3542-AH0650P20A	4mm ² /11AWG	2P—16A (with arc extinguishing function)
HP3522-AH1250P20A	6mm ² /10AWG	2P—25A (with arc extinguishing function)

When two PV arrays are connected independently, the wire and circuit breaker size of each PV array are as follows:

Model	PV wire size	Circuit breaker
HP5542-AH1050P20A	6mm ² /10AWG	2P—25A (with arc extinguishing function)

When two PV arrays are connected in parallel, the wire and circuit breaker size are as follows:

Model	PV wire size	Circuit breaker
HP5542-AH1050P20A	10mm ² /7AWG	2P—50A (with arc extinguishing function)



CAUTION

When the PV modules are connected in series, the total voltage must not exceed the max. PV open circuit voltage 440V (at 25°C).

➤ **Recommended Utility wire size**

Model	Utility wire size	Circuit breaker
HP2022-AH0750P20A	3.1 mm ² /12AWG	2P—16A
HP3522-AH1250P20A HP3542-AH0650P20A	6mm ² /10AWG	2P—32A
HP5542-AH1050P20A	10mm ² /7AWG	2P—50A



CAUTION

The utility input has the circuit breaker already; no need to add any more.

➤ **Recommended battery wire and breaker size**

Model	Battery wire size	Circuit breaker
HP2022-AH0750P20A HP3542-AH0650P20A	20mm ² /4AWG	2P—125A
HP5542-AH1050P20A HP3522-AH1250P20A	35 mm ² /2AWG	2P—200A



CAUTION

The recommended battery breaker size is selected when the battery terminals are not connected to any additional inverter.

➤ **Recommended load wire size**



Model	Load wire size	Circuit breaker
HP2022-AH0750P20A	3.1 mm ² /12AWG	2P—16A
HP3522-AH1250P20A HP3542-AH0650P20A	6mm ² /10AWG	2P—32A
HP5542-AH1050P20A	10mm ² /7AWG	2P—50A



CAUTION

- The wire size is only for reference. Suppose a long distance exists between the PV array, the inverter/charger, and the battery. In that case, larger wires shall be used to reduce the voltage drop and improve the system's performance.
- The above wire and circuit breaker sizes are for reference only; please choose a suitable wire and circuit breaker according to the actual situation.

3.3 Mounting the inverter/charger

 WARNING	Risk of explosion! Never install the inverter/charger in a sealed enclosure with flooded batteries! Do not install the inverter/charger in a confined area where the battery gas can accumulate.
 CAUTION	The inverter/charger can be fixed to the concrete and solid brick walls, while it cannot be fixed to the hollow brick wall. The inverter/charger requires at least 30cm of clearance right and left, and 50cm of clearance above and below.

Step1: Determine the installation location and heat-dissipation space. The inverter/charger requires at least 30cm of clearance right and left, and 50cm of clearance above and below.

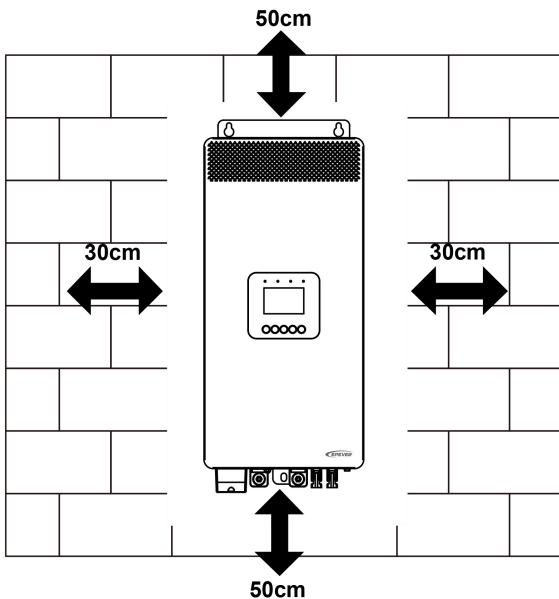

Step2: According to the installation position marked with the mounting plate 1, drill two M10 holes with an electric drill.

Step3: Insert the screws of the M8 bolts and the steel pipes into the two M10 holes.

Step4: Install the inverter/charger and determine the installation position of the M10 hole (located at the

bottom of the inverter/charge).



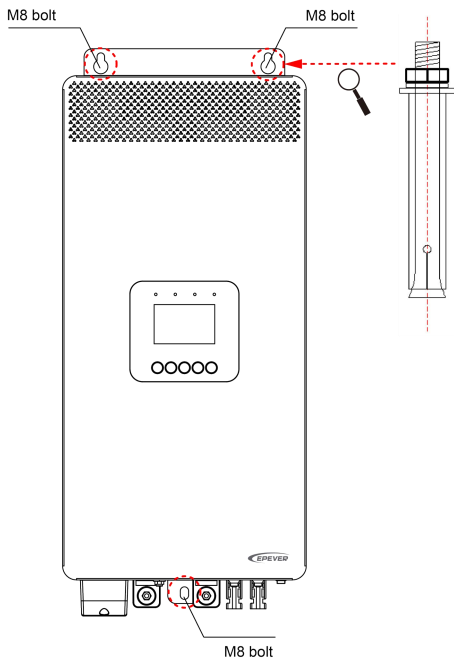

Step5: Remove the inverter/charger and drill an M10 hole according to the position determined in **step4**.

Step6: Insert the screw of the M8 bolt and the steel pipe into the M10 hole.

Step7: Install the inverter/charger and secure the nuts with a sleeve.



3.4 Wiring the inverter/charger

Connect the inverter/charger in the order of "①Ground > ②Battery  > ③Load  > ④PV  > ⑤Utility  or Generator > ⑥Optional accessories", and disconnect the inverter/charger in the reverse order. The following wiring sequence is illustrated in the appearance of "HP5542-AH1050P20A." For wiring positions of other models, please refer to the actual product appearance.

- No battery mode

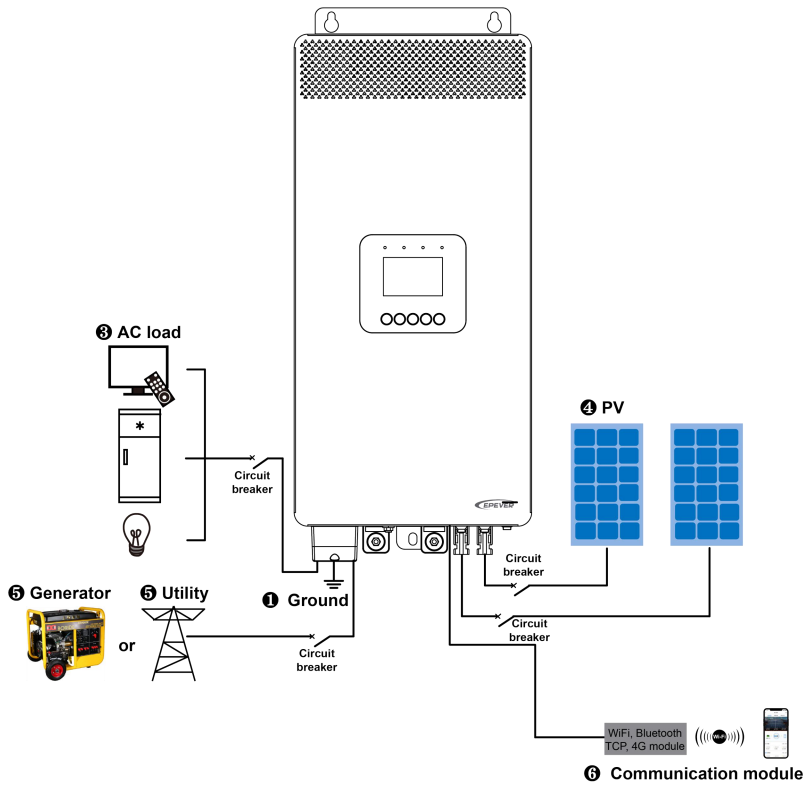

- **Battery mode**

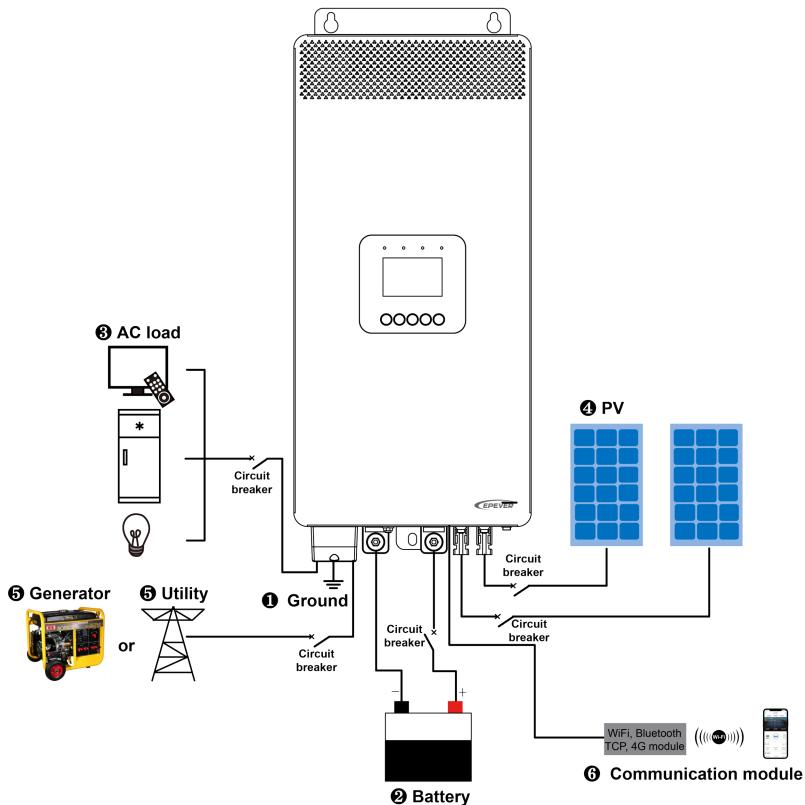

1. Grounding

The inverter/charger has a dedicated grounding terminal, which must be grounded reliably. The grounding wire size must be consistent with the recommended load wire size. The grounding connection point shall be as close as possible to the inverter/charger, and the total grounding wire shall be as short as possible.

No grounding	❌ Do not ground the battery terminals.
	❌ Do not ground the PV terminals.
	❌ Do not ground the AC input L and N terminals between the inverter/charger and the household power distribution cabinet.
	❌ Do not ground the AC output L and N terminals.
Grounding	✅ The cabinet of the inverter/charger is connected to earth through the earth rail, along with the AC input and output's PE (Protective Earth) terminal.

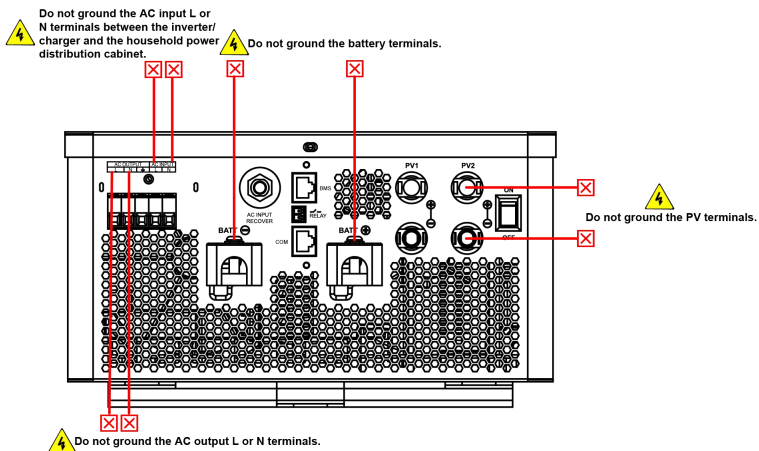

2. Connect the battery

 CAUTION	<ul style="list-style-type: none"> • Please disconnect the circuit breaker before wiring and ensure that the leads of the "+" and "-" poles are polarity correctly. • A circuit breaker must be installed on the battery side. For selection, please refer to chapter 2.2 Wire and breaker size.
--------------------	--

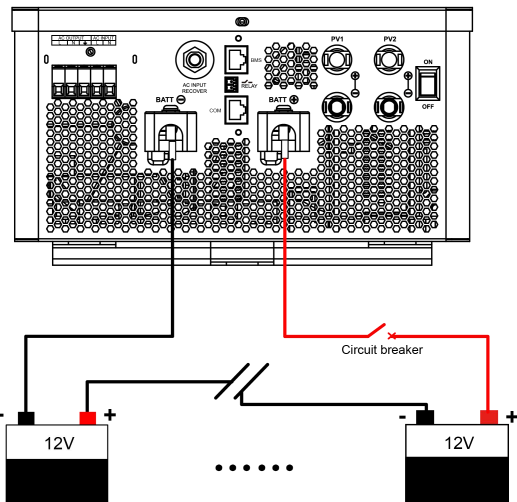

3. Connect the AC load





WARNING

- Risk of electric shock! When wiring the AC load, please disconnect the circuit breaker and ensure that the poles' leads are connected correctly.
- The AC loads shall be determined by the continuous output power of the inverter/charger. The AC load's surge power must be lower than the instantaneous surge power of the inverter/charger, or the inverter/charger will be damaged.
- If inductive loads such as motors, or a bidirectional transfer switch is connected to the AC output terminal, a separate overvoltage and overcurrent protector (VA-Protector) needs to be installed at the AC output terminal.

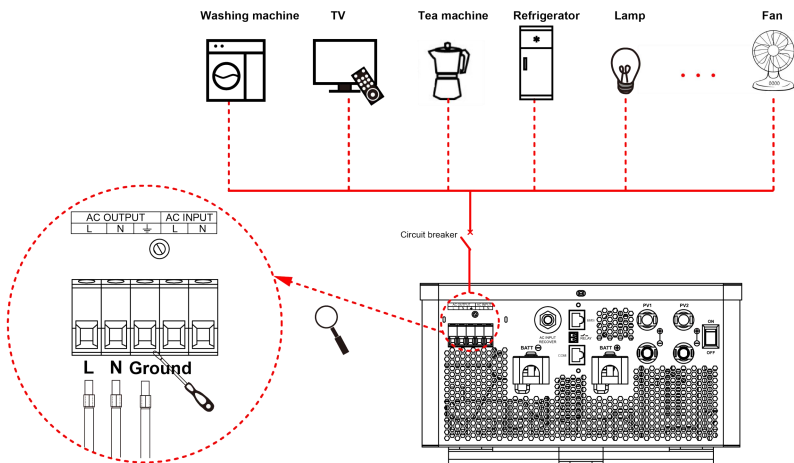
Silk-screen	Abbreviation	Name	Color
L	LINE	Live wire	Brown/black
N	Neutral	Neutral line	Blue
	PE	Ground line	Yellowish-green



4. Connect the PV modules

 WARNING	<ul style="list-style-type: none"> • Risk of electric shock! The PV array can generate dangerous high-voltage! Disconnect the circuit breaker before wiring, and ensure that the leads of "+" and "-" poles are connected correctly. • It is forbidden to connect the positive and negative poles of the PV with the ground; otherwise, the inverter/charger will be damaged.
 CAUTION	<p>Suppose the inverter/charger is used in an area with frequent lightning strikes. In that case, install an external surge arrester at the PV input and utility input terminals is a must.</p>

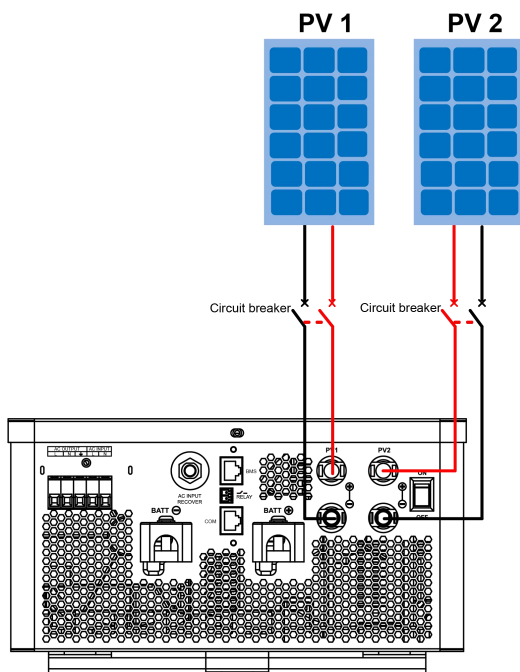

5. Connect the Utility or generator



WARNING

- Risk of electric shock! The Utility input can generate dangerous high-voltage! Disconnect the circuit breaker or fast-acting fuse before wiring, and ensure that the poles' leads are connected correctly.
- After the Utility is connected, the PV and battery cannot be grounded. In contrast, the inverter/charger cover must be grounded reliably (to shield the outside electromagnetic interference effectively and prevent the cover from causing electric shock to the human body).



CAUTION

There are many types of oil generators with complex output conditions, which must be tested before use.

Silk-screen	Abbreviation	Name	Color
L	LINE	Live wire	Brown/black
N	Neutral	Neutral line	Blue

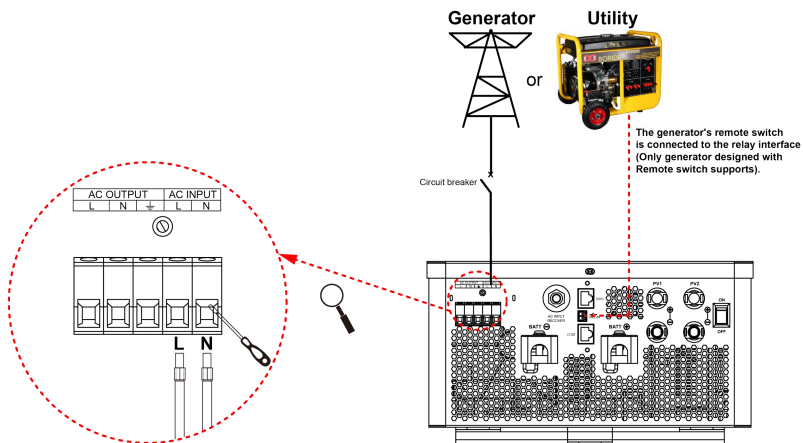

Dry contact interface:

✧ Function:

The dry contact interface can turn on/off the generator and is connected parallel with the generator's switch.

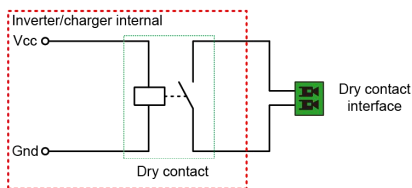

✧ Working principle:

When the battery voltage reaches the *Dry Contact ON Voltage*, the dry contact is connected. Its coil is energized. The dry contact can drive loads of no more than 125VAC /1A, 30VDC/1A. According to different battery types of the inverter charger, the default values of the *Dry Contact ON Voltage* and the *Dry Contact OFF Voltage* are different. Please refer to the chapter [2.5.1 Parameters list](#) for details.

6. Connect optional accessories

Connect the communication module

Connect the WiFi module, Bluetooth module, TCP module, or 4G module to the RS485 com. port. End-users can remote monitor the inverter/charger or modify related parameters on the phone APP. Detailed setting methods, refer to the cloud APP, WiFi, Bluetooth, TCP, or 4G module user manual.

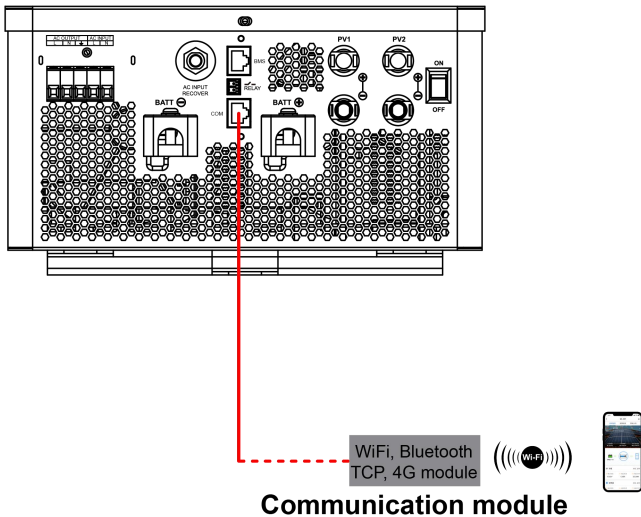

Note: For the specific communication modules supported, please refer to the accessories list file.

3.5 Operate the inverter/charger

Step 1: Double-check whether the wire connection is correct.

Step 2: Connect the battery circuit breaker.

Step 3: Turn on the power switch. The LCD will be lit, which means the system running is normal.

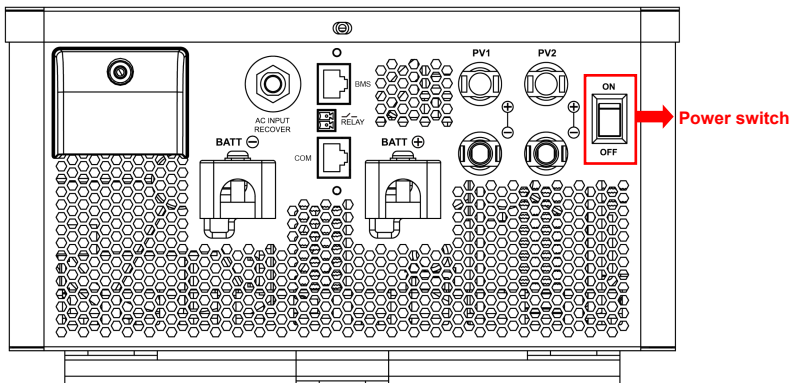

WARNING

- Connect the battery circuit breaker first. After the inverter/charger normally works, connect the PV array and utility circuit breakers later. Otherwise, we won't assume any responsibility for not following the operation.
- The AC output is ON by default after the inverter/charger is powered. Before turning on the power switch, ensure the AC output is connected to loads correctly, and no safety hazard exists.

Step 4: Set parameters by the buttons.



CAUTION

For detailed parameters setting, refer to chapter [2.5 Parameters setting](#).

Step 5: Use the inverter/charger.

Connect the load circuit breaker, the PV array circuit breaker, and the utility circuit breaker in sequence. After the AC output is normal, turn on the AC loads one by one. Do not turn on all the loads simultaneously to avoid protection action due to a large transient impulse from the current. The inverter/charger will perform normal work according to the set working mode. See chapter [2.4 Interface](#).



CAUTION

- When supplying power for different AC loads, turning on the load with a larger impulse current first is recommended. After the load output is stable, turn on the load with a smaller impulse current later.
- If the inverter/charger cannot work properly or the LCD/indicator shows an abnormality, please refer to chapter [6 Troubleshooting](#) or contact our after-sales personnel.

4 Working modes

4.1 Abbreviation

Abbreviation	Instruction
P_{PV}	PV power
P_{LOAD}	Load power
V_{BAT}	Battery voltage
LVD	Low Voltage Disconnect Voltage
LVR	Low Voltage Reconnect Voltage
LED	Low Energy Disconnect SOC
LER	Low Energy Disconnect Recover SOC
AOF	Auxiliary module OFF voltage (namely, Utility charging OFF voltage)
AON	Auxiliary module ON voltage (namely, Utility charging ON voltage)
UCF	Utility Charging OFF SOC
UCO	Utility Charging ON SOC
MCC	Battery Max. Charging Current
SOC	The battery charging state, which indicates the ratio of the current storage capacity dividing the maximum storage capacity. This value is automatically read from the BMS and displayed on the "BAT DATA" screen.
PV>BP>BT	Discharging Mode: PV>Bypass>Battery
PV>BT>BP	Discharging Mode: PV>Battery>Bypass
BP>PV>BT	Discharging Mode: Bypass>PV>Battery

4.2 Battery mode

4.2.1 Scenario A: Both PV and Utility are not available.

<p>(A)</p> <p>PV <input checked="" type="checkbox"/></p> <p>Utility <input checked="" type="checkbox"/></p>	<p>Regardless of the input and output sources, the working mode is as follows.</p>
	<div style="border: 1px solid black; padding: 5px; margin-bottom: 10px;"> <p>2023-03-28 15:40 AGM</p> <p>EPEVER Status: OK</p> </div> <p> $V_{BAT} \geq LVR$ / $SOC \geq LER$ $V_{BAT} \leq LVD$ / $SOC \leq LED$ </p>

① Any of the following is satisfied, the battery supplies the load.

- The battery voltage is greater than or equal to the LVR value.
- The battery SOC is greater than or equal to the LER value.

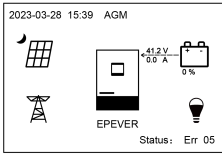
		<p>② Any of the following is satisfied, the battery stops supplying the load.</p> <ul style="list-style-type: none"> The battery voltage is lower than or equal to the LVD value. The battery SOC is lower than or equal to the LED value.
--	---	--

 <p>CAUTION</p>	<ul style="list-style-type: none"> Set the "Charge Control Mode" as "VOLT," the working mode is determined by the battery voltage value. Set the "Charge Control Mode" as "SOC," the working mode is determined by the battery SOC. The battery SOC value will be more accurate after a full charge-discharge cycle when the "Charge Control Mode" is set to "VOLT." For setting the "Charge Control Mode", refer to chapter 2.5.1 Parameters list.
---	--

4.2.2 Scenario B: PV is available, but the Utility is not available.

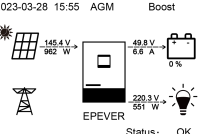
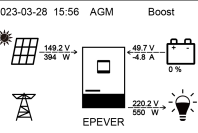
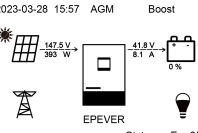
<p>(B)</p> <p>PV <input checked="" type="checkbox"/></p> <p>Utility <input checked="" type="checkbox"/></p>	<p>Regardless of the input and output sources, the working mode is as follows.</p> <div data-bbox="259 662 497 822"> <p>2023-03-28 15:55 AGM Boost</p>  </div> <p>$P_{PV} > P_{LOAD} \iff P_{PV} \leq P_{LOAD}$</p> <div data-bbox="259 880 497 1041"> <p>2023-03-28 15:56 AGM Boost</p>  </div> <p>$V_{BAT} \geq LVR \iff V_{BAT} \leq LVD$ $SOC \geq LER \iff SOC \leq LED$</p> <div data-bbox="259 1113 497 1274"> <p>2023-03-28 15:57 AGM Boost</p>  </div>	<p>① When the PV power is greater than the load power, the PV charges the battery and supplies extra power to the load.</p> <p>② When the PV power is lower than or equal to the load power, the PV will not charge the battery, the battery will cut in to supply power to the load together with the PV.</p> <p>③ Any of the following is satisfied, the PV and the battery stop supplying power to the load. The PV charges the battery only.</p> <ul style="list-style-type: none"> The battery voltage is lower than or equal to the LVD value. The battery SOC is lower than or equal to the LED value.
---	---	---

Note: When the battery voltage is greater than or equal to the LVR value, or the battery SOC is greater than or equal to the LER value, the working mode returns to state ②.

4.2.3 Scenario C: Both PV and Utility are available.

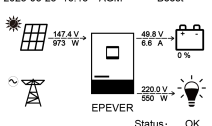
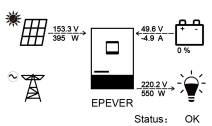
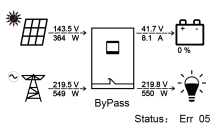
Charging Mode: "Solar"	Discharging Mode: " <u>PV</u> > <u>BP</u> > <u>BT</u> " or " <u>PV</u> > <u>BT</u> > <u>BP</u> "
<p>2023-03-28 16:18 AGM Boost</p>  <p>Status: OK</p>	<p>① When the PV power is greater than load power, the PV charges the battery and supplies extra power to the load.</p>
$P_{PV} > P_{LOAD} \quad \updownarrow \quad P_{PV} \leq P_{LOAD}$	<p>② When the PV power is lower than or equal to the load power, the PV will not charge the battery, the battery will cut in to supply power to the load together with the PV.</p>
<p>2023-03-28 16:18 AGM Boost</p>  <p>Status: OK</p>	<p>③ Any of the following is satisfied, the Utility supplies power to the load and the PV charges the battery.</p> <ul style="list-style-type: none"> The battery voltage is lower than or equal to the LVD value. The battery SOC is lower than or equal to the LED value.
$\begin{matrix} V_{BAT} \geq LVR \\ / \\ SOC \geq LER \end{matrix} \quad \updownarrow \quad \begin{matrix} V_{BAT} \leq LVD \\ / \\ SOC \leq LED \end{matrix}$	<p>• The battery voltage is lower than or equal to the LVD value.</p> <p>• The battery SOC is lower than or equal to the LED value.</p>
<p>2023-03-28 16:19 AGM Boost</p>  <p>Status: Err 05</p>	<p>Note: When the battery voltage is greater than or equal to the LVR value, or the battery SOC is greater than or equal to the LER value, the working mode returns to state ②.</p>

(C-1)

PV

Utility

(C-2) PV <input checked="" type="checkbox"/> Utility <input checked="" type="checkbox"/>	Charging Mode: "Solar"	Discharging Mode: "BP>PV>BT"
		<p>The Utility supplies power to the load, and the PV charges the battery.</p>

(C-3) PV <input checked="" type="checkbox"/> Utility <input checked="" type="checkbox"/>	Charging Mode: "Solar prior"	Discharging Mode: "PV>BP>BT" or "PV>BT>BP"
		<p>① When the PV power is greater than the load power, the PV charges the battery and supplies extra power to the load.</p>
	$P_{PV} > P_{LOAD} \quad \updownarrow \quad P_{PV} \leq P_{LOAD}$	<p>② When the PV power is lower than or equal to the load power, the PV will not charge the battery, the battery will cut in to supply power to the load together with the PV.</p>
		<p>③ Any of the following is satisfied, the Utility supplies power to the load and charges the battery together with the PV.</p> <ul style="list-style-type: none"> • The battery voltage is lower than or equal to the AON value. • The battery SOC is lower than or equal to the UCO value.
	$V_{BAT} \geq AOF \quad \updownarrow \quad V_{BAT} \leq AON$ $/ SOC \geq UCF \quad \updownarrow \quad / SOC \leq UCO$	
	<p>Note: When the battery voltage is greater than or equal to the AOF value, or the battery SOC is greater than or equal to the UCF value, the working mode returns to state ②.</p>	

		Charging Mode: "Solar prior"	Discharging Mode: "BP>PV>BT"
<p>(C-4)</p> <p>PV <input checked="" type="checkbox"/></p> <p>Utility <input checked="" type="checkbox"/></p>		<p>1 When the PV power is greater than the ($MCC \cdot V_{BAT}$), the Utility and PV supply power to the load, and the PV charges the battery at the same time.</p>	
	$P_{PV} > MCC \cdot V_{BAT} \quad \updownarrow \quad P_{PV} \leq MCC \cdot V_{BAT}$		<p>2 When the PV power is lower than or equal to the ($MCC \cdot V_{BAT}$), the Utility supplies power to the load and the PV charges the battery.</p>
	$V_{BAT} \geq AOF \quad \updownarrow \quad V_{BAT} \leq AON$ $/ \quad SOC \geq UCF \quad \updownarrow \quad / \quad SOC \leq UCO$		<p>3 Any of the following is satisfied, the Utility supplies power to the load and charges the battery together with the PV.</p> <ul style="list-style-type: none"> The battery voltage is lower than or equal to the AON value. The battery SOC is lower than or equal to the UCO value.
		<p>Note: When the battery voltage is greater than or equal to the AOF value, or the battery SOC is greater than or equal to the UCF value, the working mode returns to state 2.</p>	

		Charging Mode: "Utly & solr"	Discharging Mode: No impact under any mode
<p>(C-5)</p> <p>PV <input checked="" type="checkbox"/></p> <p>Utility <input checked="" type="checkbox"/></p>		<p>1 When the PV power is greater than the ($MCC \cdot V_{BAT}$), the Utility and PV supply power to the load, and the PV charges the battery simultaneously.</p>	
	$P_{PV} > MCC \cdot V_{BAT} \quad \updownarrow \quad P_{PV} \leq MCC \cdot V_{BAT}$		

		<p>② When the PV power is lower than or equal to the $(MCC \cdot V_{BAT})$, the Utility and PV charge the battery, and the Utility supplies power to the load.</p>
--	--	---

<p>(C-6)</p> <p>PV <input checked="" type="checkbox"/></p> <p>Utility <input checked="" type="checkbox"/></p>	<p>Charging Mode: "Uttyprior"</p>	<p>Discharging Mode: No impact under any mode</p>
		<p>The Utility supplies power to the load and charges the battery simultaneously.</p>

4.2.4 Scenario D: The PV is not available, but the Utility is available.

<p>(D-1)</p> <p>PV <input checked="" type="checkbox"/></p> <p>Utility <input checked="" type="checkbox"/></p>	<p>Charging Mode: "Solar"</p>	<p>Discharging Mode: "PV>BT>BP"</p>
	<p>$V_{BAT} \geq LVR$ / $SOC \geq LER$ \leftrightarrow $V_{BAT} \leq LVD$ / $SOC \leq LED$</p>	<p>① Any of the following is satisfied, the battery supplies the load.</p> <ul style="list-style-type: none"> The battery voltage is greater than or equal to the LVR value. The battery SOC is greater than or equal to the LER value. <p>② Any of the following is satisfied, the Utility supplies power to the load.</p> <ul style="list-style-type: none"> The battery voltage is lower than or equal to the LVD value. The battery SOC is lower than or equal to the LED value.

<p>(D-2)</p> <p>PV <input checked="" type="checkbox"/></p> <p>Utility <input checked="" type="checkbox"/></p>	<p>Charging Mode: "Solar"</p>	<p>Discharging Mode: "PV>BP>BT" or "BP>PV>BT"</p>
		<p>The Utility supplies power to the load.</p>

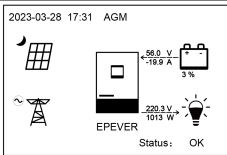
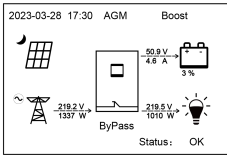
<p>(D-3)</p> <p>PV <input checked="" type="checkbox"/></p> <p>Utility <input checked="" type="checkbox"/></p>	<p>Charging Mode: "Solar prior"</p>  <p>2023-03-28 17:31 AGM</p> <p>$V_{BAT} \geq AOF$ / $SOC \geq UCF$ $V_{BAT} \leq AON$ / $SOC \leq UCO$</p>	<p>Discharging Mode: "PV>BT>BP"</p> <p>① Any of the following is satisfied, the battery supplies the load.</p> <ul style="list-style-type: none"> The battery voltage is higher than or equal to the AOF value. The battery SOC is greater than or equal to the UCF value.
	<p>Boost</p>  <p>2023-03-28 17:30 AGM Boost</p>	<p>② Any of the following is satisfied, the Utility supplies power to the load and charges the battery simultaneously.</p> <ul style="list-style-type: none"> The battery voltage is lower than or equal to the AON value. The battery SOC is lower than or equal to the UCO value.

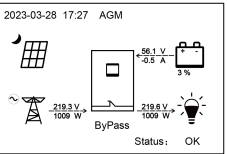
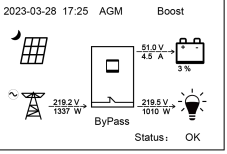
<p>(D-4)</p> <p>PV <input checked="" type="checkbox"/></p> <p>Utility <input checked="" type="checkbox"/></p>	<p>Charging Mode: "Solar prior"</p>  <p>2023-03-28 17:27 AGM</p> <p>$V_{BAT} \geq AOF$ / $SOC \geq UCF$ $V_{BAT} \leq AON$ / $SOC \leq UCO$</p>	<p>Discharging Mode: "PV>BP>BT" or "BP>PV>BT"</p> <p>① Any of the following is satisfied, the Utility supplies power to the load.</p> <ul style="list-style-type: none"> The battery voltage is greater than or equal to the AOF value. The battery SOC is greater than or equal to the UCF value.
	<p>Boost</p>  <p>2023-03-28 17:25 AGM Boost</p>	<p>② Any of the following is satisfied, the Utility supplies power to the load and charges the battery simultaneously.</p> <ul style="list-style-type: none"> The battery voltage is lower than or equal to the AON value. The battery SOC is lower than or equal to the UCO value.

(D-5) PV <input checked="" type="checkbox"/> Utility <input checked="" type="checkbox"/>	Charging Mode: "Utly & solr" or "Utlyprior"	Discharging Mode: No impact under any mode



The Utility supplies power to the load and charges the battery simultaneously.

4.3 No battery mode

Note: Under the no battery mode, the "Charging Mode" and "Discharging Mode" settings will not take effect.

PV <input checked="" type="checkbox"/> Utility <input checked="" type="checkbox"/>		<p>① When the PV power is greater than the load power; the PV supplies power to the load.</p> <p>Note: In this mode, the Utility still keep a minimum power input. When the PV power is lower than the load power, the Utility can replenish the power supply at any time to avoid device shutdown.</p>
	$P_{PV} > P_{LOAD}$ \updownarrow $P_{PV} \leq P_{LOAD}$	
PV <input checked="" type="checkbox"/> Utility <input checked="" type="checkbox"/>		<p>Only the PV supplies power to the load.</p>
PV <input checked="" type="checkbox"/> Utility <input checked="" type="checkbox"/>		<p>Only the Utility supplies power to the load.</p>

5 Protections

No.	Protections	Instruction
1	PV limit Current/Power	When the PV array's actual charging current/power exceeds its rated current/power, it will charge the battery as per the rated current/power. When the PV voltage exceeds the bus voltage, the PV input power is constrained by the load power, charging power, the power that the solar panels can deliver, and the current of the PV circuit breaker.
2	PV short circuit	When the PV is not charging and short circuit, the inverter/charger is not damaged.
3	PV Reverse Polarity	<p>The inverter/charger will not be damaged when the PV array is reversely connected, correct the wire connection to resume work.</p> <p> CAUTION: The total short-circuit current of each PV array must be less than the "PV Maximum Short-circuit Current" (see section 8 Specifications), and the reverse connection time should not exceed 5 minutes. Frequent incorrect wiring is strictly prohibited as it may damage the inverter/charger.</p> <p> CAUTION: The PV input terminals must first be connected to a DC circuit breaker with an arc extinguishing function capable of handling 500VDC or higher, and then, connect the PV input terminals to the inverter/charger. If the PV array is reversely connected, it is essential to first disconnect the external circuit breaker, followed by the PV standard terminals, or the PV connection terminals of the inverter/charger. Otherwise, it may result in arcing damage to the PV standard terminals or the inverter/charger.</p>
4	Utility input over-voltage	When the utility voltage exceeds the set value of "Utility over voltage disconnect voltage", the utility will stop charging and supplying the load.
5	Utility input under-voltage	When the utility voltage is lower than the set value of "Utility low voltage disconnect voltage", the utility will stop charging and supplying the load.

No.	Protections	Instruction			
6	Battery reverse polarity	Fully protected against reverse battery polarity; no damage will occur to the battery. Correct the miswire to resume operation.  CAUTION: The inverter/charger will be damaged when the PV/Utility is correct connected and the battery is reversed connected.			
7	Battery over-voltage	When the battery voltage goes higher than the [Over Voltage Disconnect Voltage], the PV/Utility will stop charging the battery to protect the battery from being over-charged.			
8	Battery over-discharge	When the battery voltage goes lower than the [Low Voltage Disconnect Voltage], the battery will stop discharging to protect the battery from being over-discharged.			
9	Load output short circuit	The output is turned off immediately in the occurrence of short-circuiting. And then, the output is recovered automatically after a delay time of 5s, 10s, and 15s separately (less than three times recovery within 5 minutes, it will be recounted). The inverter/charger stops working after the 4th protection and can resume working after resetting or restarting. Clear the fault in time because it may damage the inverter/charger permanently. Note: Resetting operation--See chapter 2.4.3 Administrator interface to enter the "5. Basic Param Setup" screen, and then click the UP/DOWN button to locate the "FR (fault reset)" menu. Click the ENTER button to exit the current fault state and resume normal operation.			
10	Device overheating	When the internal temperature overheats, the inverter/charger will stop charging/discharging. The inverter/charger will resume charging/discharging when the internal temperature is normal and the protection time lasts more than 20 minutes.			
11	HP2022-AH0750P20A Inverter overload (no Utility)	2060W≤P<2600W	2600W≤P<3000W	3000W≤P<4000W	P≥4000W
		Protect after 30 seconds	Protect after 10 seconds	Protect after 5 seconds	Protect immediately
		Note: The output is recovered automatically after a delay time of 5s, 10s, and 15s separately. The inverter/charger stops working after the 4th protection and can resume working after resetting or restarting.			

No.	Protections	Instruction			
12	HP2022-AH0750P20A Utility bypass overload (no-Battery mode)	2200W≤P<2740W	2740W≤P<3140W	3140W≤P<4000W	P≥4000W
		Protect after 30 seconds	Protect after 10 seconds	Protect after 5 seconds	Protect immediately
		Note: The output is recovered automatically after a delay time of 5s, 10s, and 15s separately. The inverter/charger stops working after the 4th protection and can resume working after resetting or restarting.			
13	HP2022-AH0750P20A Utility bypass overload (Battery mode)	3050W≤P<3600W	3600W≤P<4000W	4000W≤P<4850W	P≥4850W
		Protect after 30 seconds	Protect after 10 seconds	Protect after 5 seconds	Protect immediately
		Note: The output is recovered automatically after a delay time of 5s, 10s, and 15s separately. The inverter/charger stops working after the 4th protection and can resume working after resetting or restarting.			
14	HP3522-AH1250P20A HP3542-AH0650P20A Inverter overload (no Utility)	3605W≤P<4550W	4550W≤P<5250W	5250W≤P<7000W	P≥7000W
		Protect after 30 seconds	Protect after 10 seconds	Protect after 5 seconds	Protect immediately
		Note: The output is recovered automatically after a delay time of 5s, 10s, and 15s separately. The inverter/charger stops working after the 4th protection and can resume working after resetting or restarting.			
15	HP3522-AH1250P20A HP3542-AH0650P20A Utility bypass overload (no-Battery mode)	3850W≤P<4795W	4795W≤P<5495W	5495W≤P<7000W	P≥7000W
		Protect after 30 seconds	Protect after 10 seconds	Protect after 5 seconds	Protect immediately
		Note: The output is recovered automatically after a delay time of 5s, 10s, and 15s separately. The inverter/charger stops working after the 4th protection and can resume working after resetting or restarting.			
16	HP3522-AH1250P20A HP3542-AH0650P20A Utility bypass overload (Battery mode)	5350W≤P<6295W	6295W≤P<6995W	6995W≤P<8500W	P≥8500W
		Protect after 30 seconds	Protect after 10 seconds	Protect after 5 seconds	Protect immediately
		Note: The output is recovered automatically after a delay time of 5s, 10s, and 15s separately. The inverter/charger stops working after the 4th protection and can resume working after resetting or restarting.			

No.	Protections	Instruction		
17	HP5542-AH1050P20A Inverter overload (no Utility)	5665W≤P<6600W	6600W≤P<7700W	P≥7700W
		Protect after 30 seconds	Protect after 10 seconds	Protect after 5 seconds
		Note: The output is recovered automatically after a delay time of 5s, 10s, and 15s separately. The inverter/charger stops working after the 4th protection and can resume working after resetting or restarting.		
18	HP5542-AH1050P20A Utility bypass overload (no-Battery mode)	6050W≤P<6985W	6985W≤P<8085W	P≥8085W
		Protect after 30 seconds	Protect after 10 seconds	Protect after 5 seconds
		Note: The output is recovered automatically after a delay time of 5s, 10s, and 15s separately. The inverter/charger stops working after the 4th protection and can resume working after resetting or restarting.		
19	HP5542-AH1050P20A Utility bypass overload (Battery mode)	8550W≤P<9485W	9485W≤P<10585W	P≥10585W
		Protect after 30 seconds	Protect after 10 seconds	Protect after 5 seconds
		Note: The output is recovered automatically after a delay time of 5s, 10s, and 15s separately. The inverter/charger stops working after the 4th protection and can resume working after resetting or restarting.		

6 Troubleshooting

 CAUTION	<p>After the inverter/charger is powered on, the meter displays the boot screen all the time (unable to enter the home screen) and the red "RUN" indicator flashes. It means the communication with the inverter/charger is error. When the above fault occurs, check whether the communication cable is disconnected. If not, don't hesitate to contact our after-sales engineer.</p>
---	--

6.1 Battery faults

No.	Fault/Status	Error code ^①	Indicator	Buzzer	Solution
1	BAT OVP (Battery over voltage protection)	Err4	--	--	Disconnect the utility and PV connection, and check whether the battery voltage is too high. Verify if the actual battery voltage matches the rated battery voltage; or check if the "over voltage disconnect voltage" is inconsistent with the battery specifications. After the battery voltage drops below the set value of "over voltage reconnect voltage", the alarm will automatically be cleared.
2	BAT UVP (Battery under voltage protection)	Err5			Disconnect the loads connection, and check whether the battery voltage is too low. After the battery voltage is charged and restored to above the "low voltage reconnect voltage", it will automatically return to normal, or use other methods to charge the battery.
3	BAT OTP (Battery over temperature protection)	Err11			Ensure the battery is installed in a cool and well-ventilated place, check that the battery actual charging and discharging current does not exceed the setting values of "Battery Max. charging current " and "Battery limit discharging current." It resumes normal work when the battery cools down to below the "Battery over temperature protect recover."

No.	Fault/Status	Error code ^①	Indicator	Buzzer	Solution
4	BAT OCP (Battery over current protection)	Err37	--	--	Check that the battery actual charging and discharging current does not exceed the setting values of "Battery Max. charging current " and "Battery limit discharging current."
5	BAT DROP (Battery dropout)	Err39			Check whether the battery connection is normal, and whether the BMS protection occurs.
6	BAT UNDERVOLT WARN (Battery under voltage warning)	Err50			Check if the battery voltage is lower than the "under voltage warning voltage"
7	BAT FTA (Battery fail to activate)	Err56			Check if the battery connection is normal and the BMS communication of the lithium battery is normal.

① The fault/status code is displayed in the "Status" column at the bottom right corner of the LCD. When multiple faults occur simultaneously, the LCD only displays the fault code with the smallest value.

6.2 PV faults

No.	Fault/Status	Error code ^①	Indicator	Buzzer ^②	Solution
1	PV1 OVP (PV1 over voltage protection)	Err15	PV indicator red on	Intermittent beeps	Check if the PV open-circuit voltage is too high (greater than 500 V). The alarm is released when the PV open-circuit voltage is below 490 V.
2	PV1 OCP (PV1 over current protection)	Err17	PV indicator green on	--	Turn off the inverter/charger first, wait for 5 minutes and then turn on the inverter/charger to check if it resumes normal. If it is still abnormal, please contact our technical support.
3	PV2 OVP (PV2 over voltage protection)	Err18	PV indicator red on	Intermittent beeps	Check if the PV open-circuit voltage is too high (greater than 500 V). The alarm is released when the PV open-circuit voltage is below 490 V.
4	PV2 OCP (PV2 over current protection)	Err20	PV indicator green on	--	Turn off the inverter/charger first, wait for 5 minutes and then turn on the inverter/charger to check if it resumes normal. If it is still abnormal, please contact our technical support.
5	PV HARD FAULT (PV hardware fault)	Err30			
6	PV1TS NC (PV1 temperature sensor no connection)	Err43			
7	PV1 PCTO (PV1 pre-charge timeout)	Err52	PV indicator green on	--	Turn off the inverter/charger first, wait for 5 minutes and then turn on the inverter/charger to check if it resumes normal. If it is still abnormal, please contact our technical support.
8	PV2 PCTO (PV2 pre-charge timeout)	Err53			

① The fault/status code is displayed in the "Status" column at the bottom right corner of the LCD. When multiple faults occur simultaneously, the LCD only displays the fault code with the smallest value.

②Set the "BuzzerAlert" as "ON," the buzzer will sound when a fault occurs. After the fault is eliminated, the buzzer will automatically mute. If the "BuzzerAlert" is set as "OFF," even if a fault occurs, the buzzer will not sound.

6.3 Inverter faults

No.	Fault/Status	Error code①	Indicator	Buzzer②	Solution
1	INV OCP (Inverter over current protection)	Err2	LOAD indicator red ON	Intermittent beeps	Check if the load actual power exceeds the rated power (namely, the inverter/charger's continuous output power), disconnect the load completely and turn off the inverter/charger. Wait 5 minutes and then turn on the inverter/charger to check if it resumes normal. If it is still abnormal, please contact our technical support.
2	INV OVP (Inverter over voltage protection)	Err7	LOAD indicator red ON	Intermittent beeps	Disconnect the load completely and turn off the inverter/charger. Wait 5 minutes and then turn on the inverter/charger to check if it resumes normal. If it is still abnormal, please contact our technical support.
3	INV OTP (Inverter over temperature protection)	Err10	--	--	Ensure the inverter/charger is installed in a cool and well-ventilated place.
4	HARD INV OVP (Inverter hardware over voltage protection)	Err22	--	--	Disconnect the load completely and turn off the inverter/charger. Wait 5 minutes and then turn on the inverter/charger to check if it resumes normal. If it is still abnormal, please contact our technical support.
5	HARD INV OCP (Inverter hardware over current protection)	Err23			
6	INV VOLT OFFSET ERR (Inverter voltage offset error)	Err32			

No.	Fault/Status	Error code ^①	Indicator	Buzzer ^②	Solution
7	INV CURR OFFSET ERR (Inverter current offset error)	Err35	--	--	Disconnect the load completely and turn off the inverter/charger. Wait 5 minutes and then turn on the inverter/charger to check if it resumes normal. If it is still abnormal, please contact our technical support.
8	ITS NC (Internal temperature sensor no connection)	Err45	LOAD indicator green ON	--	Turn off the inverter/charger. Wait 5 minutes and then turn on the inverter/charger to check if it resumes normal. If it is still abnormal, please contact our technical support.
9	INV UVP (Inverter under voltage protection)	Err49	LOAD indicator red ON	Intermittent beeps	Check if the load actual power exceeds the rated power (namely, the inverter/charger's continuous output power), disconnect the load completely and turn off the inverter/charger. Wait 5 minutes and then turn on the inverter/charger to check if it resumes normal. If it is still abnormal, please contact our technical support.
10	Step-up Unit OTP	Err60	--	--	Ensure the inverter/charger is installed in a cool and well-ventilated place.

① The fault/status code is displayed in the "Status" column at the bottom right corner of the LCD. When multiple faults occur simultaneously, the LCD only displays the fault code with the smallest value.

② Set the "BuzzerAlert" as "ON," the buzzer will sound when a fault occurs. After the fault is eliminated, the buzzer will automatically mute. If the "BuzzerAlert" is set as "OFF," even if a fault occurs, the buzzer will not sound.

6.4 Utility faults

No.	Fault/Status	Error code ^①	Indicator	Buzzer ^②	Solution
1	AC OVP (AC over voltage protection)	Err8	GRID indicator red on	Intermittent beeps	Check if the utility voltage exceeds the "Utility Over Voltage Disconnect Voltage," then disconnect the AC input and turn off the inverter/charger. Wait 5 minutes and then turn on the inverter/charger to check if it resumes normal. If it is still abnormal, please contact our technical support.
2	AC OCP (AC over current protection)	Err9	GRID indicator red on	Intermittent beeps	Check if the load actual power exceeds the "Inverter Rated Power (see chapter 8 <u>Specifications</u>)," disconnect the load completely and turn off the inverter/charger. Wait 5 minutes and then turn on the inverter/charger to check if it resumes normal. If it is still abnormal, please contact our technical support. Check if the utility voltage is lower than the "Utility Low Voltage Disconnect Voltage," disconnect the utility input and turn off the inverter/charger. Wait 5 minutes and then turn on the inverter/charger to check if it resumes normal. If it is still abnormal, please contact our technical support.
3	AC UVP (AC under voltage protection)	Err25	GRID indicator red on	--	
4	AC PRECHG OUT (AC pre-charge timeout)	Err28	GRID indicator green on	--	
5	AC RELAY Adhesion (AC relay adhesion. Namely, AC relay abnormal)	Err29	GRID indicator green on	--	Check if the utility frequency in between the "Utility Under Frequency Disconnect Frequency" to "Utility Over Frequency Disconnect Frequency," disconnect the utility input and turn off the inverter/charger. Wait 5 minutes and then turn on the inverter/charger to check if it resumes normal. If it is still abnormal, please contact our technical support.
6	AC FREQ ERR (AC frequency error)	Err31	GRID indicator red on	Intermittent beeps	

①The fault/status code is displayed in the "Status" column at the bottom right corner of the LCD. When multiple faults occur simultaneously, the LCD only displays the fault code with the smallest value.

②Set the "BuzzerAlert" as "ON," the buzzer will sound when a fault occurs. After the fault is eliminated, the buzzer will automatically mute. If the "BuzzerAlert" is set as "OFF," even if a fault occurs, the buzzer will not sound.

6.5 Load faults

No.	Fault/Status	Error code ^①	Indicator	Buzzer ^②	Solution
1	LAOD CURR OFFSET ERR (Load current offset error)	Err33	--	--	Disconnect the load completely and turn off the inverter/charger. Wait 5 minutes and then turn on the inverter/charger to check if it resumes normal. If it is still abnormal, please contact our technical support.
2	OVERLOAD (Overload)	Err48	LOAD indicator red ON	Intermittent beeps	
3	OVERLOAD LOCK (Overload lock)	Err55	LOAD indicator red ON	Intermittent beeps	

①The fault/status code is displayed at the "Status" column at the bottom right corner of the LCD interface. When multiple faults occur simultaneously, the LCD only displays the fault code with the smallest value.

②Set the "BuzzerAlert" as "ON"; the buzzer will sound when a fault occurs. After the error is eliminate, the buzzer will automatically mute. If the "BuzzerAlert" is set as "OFF," even if a fault occurs, the buzzer will not sound.

6.6 Other faults for single inverter/charger

No.	Fault/Status	Error code ^①	Indicator	Buzzer	Solution
1	BUS OVP (DC bus over voltage protection)	Err0	--	--	Turn off the inverter/charger. Wait 5 minutes and then turn on the inverter/charger to check if it resumes normal. If it is still abnormal, please contact our technical support.
2	BUS UVP (DC bus under voltage protection)	Err6			
3	AMBIENT OTP (Ambient over temperature protection)	Err12	--	--	Ensure the inverter/charger is installed in a cool and well-ventilated place.
4	HARD OVP (Hardware over voltage protection)	Err21	--	--	Turn off the inverter/charger. Wait 5 minutes and then turn on the inverter/charger to check if it resumes normal. If it is still abnormal, please contact our technical support.
5	BAT CHG OCP (Battery charge over current protection)	Err24			
6	CHG CURR OFFSET ERR (Charge current offset error)	Err36			
7	PUSH DRV ERR (Push driver error)	Err38			
8	APS ERR (Auxiliary power supply error)	Err40			
9	ATS NC (Ambient temperature sensor no connection)	Err42	--	--	Turn off the inverter/charger. Wait 5 minutes and then turn on the inverter/charger to check if it resumes normal. If it is still abnormal, please contact our technical support.

No.	Fault/Status	Error code ^①	Indicator	Buzzer	Solution
10	LIMITCHG (Low temperature limit charging)	Err46	--	--	Check whether the ambient temperature is lower than the set "Charge low temperature limit" and "Discharge low temperature limit."
11	LIMITDISCHG (Low temperature limit discharging)	Err47			
12	EEP ERR (EEPROM error)	Err54	--	--	Turn off the inverter/charger. Wait 5 minutes and then turn on the inverter/charger to check if it resumes normal. If it is still abnormal, please contact our technical support.

①The fault/status code is displayed at the "Status" column at the bottom right corner of the LCD interface. When multiple faults occur simultaneously, the LCD only displays the fault code with the smallest value.

6.7 BMS faults

No.	Fault/Status	Error code ^①	Indicator	Buzzer	Solution
1	BMS OVP (BMS over voltage protect)	Err66	--	--	Check the BMS communication status or BMS setting parameters.
2	BMS Chage TEMP ERR (BMS charge temperature error)	Err68			
3	BMS UVP (BMS under voltage protect)	Err69			
4	BMS DisChageTEMP ER (BMS discharge temperature error)	Err71			
5	BMS COM ERR (BMS communication error)	Err74			

①The fault/status code is displayed in the "Status" column at the bottom right corner of the LCD. When multiple faults occur simultaneously, the LCD only displays the fault code with the smallest value.

7 Maintenance

The following inspections and maintenance tasks are recommended at least twice yearly for best performance.

- Make sure no block on airflow around the inverter/charger. Clear up dirt and fragments on the radiator.
- Check all the wired cables to ensure insulation is not damaged for serious solarization, frictional wear, dryness, insects or rats, etc. Repair or replace some wires if necessary.
- Check and confirm that LED or LCD is consistent with the required. Pay attention to any troubleshooting or error indication. Take necessary corrective action.
- Confirm that all the terminals have no corrosion, insulation damage, high temperature, or burnt/discolored sign; tighten terminal screws to the suggested torque.
- Check for dirt, nesting insects, and corrosion. If so, clear up in time.
- Check and confirm that the lightning arrester is in good condition. Replace a new one in time to avoid damaging the inverter/charger and other equipment.



WARNING

Risk of electric shock! Turn off all the power before the above operations and follow the corresponding inspections and operations.

8 Specifications

Model	HP2022-AH0750P20A	HP3522-AH1250P20A
Utility input		
Utility Voltage	176VAC to 264VAC (Default) 90VAC to 280VAC (Configurable)	
Utility Frequency	45Hz to 65Hz	
Maximum Utility Charging Current	70A	110A
Switch Response Time	Switch Response Time – Inverter to Utility: 10ms Switch Response Time – Utility to Inverter (when the load power is higher than 100W): 20ms	
Inverter output		
Inverter Rated Power (@30°C)	2000W	3500W
3-second Transient Surge Output Power	4000W	7000W
Inverter Output Voltage	220/230VAC±3%	
Inverter Frequency	50/60Hz±0.2%	
Output Voltage Waveform	Pure sine wave	
Load Power Factor	0.2 – 1 (VA ≤ Rated output power)	
THDu (Total Harmonic Voltage Distortion)	≤3% (24V resistive load)	
Maximum Load Efficiency	90%	90%
Maximum Inverter Efficiency	92%	93%
Parallel Function	Yes, 12 units in standard, 16 units at most	
Solar controller		
PV Maximum Open-circuit Voltage	500V (At minimum operating environment temperature) 440V (At 25°C)	
MPPT Voltage Range	85V to 400V	
PV Maximum Input Power	3000W	4000W
MPPT Input Channels	One way	
PV Maximum Input Current	One way, 10A	One way, 16A
PV Maximum Short-circuit Current	One way, 12A	One way, 18A
PV Maximum Charging Current	70A	120A
MPPT Maximum efficiency	≥99.5%	
Battery		
Battery Rated Voltage	24VDC	
Battery Work Voltage Range	21.6VDC to 32.0VDC	
Battery Maximum Charging Current	70A	120A

Others		
No-load Losses	<1.1 A	<1.2A
	Test condition: Utility, PV and Load are not connected, AC output is ON, fan stops, @24V input	
Standby Current	<0.9A	<0.9A
	Test condition: Utility, PV and Load are not connected, AC output is OFF, fan stops, @24V input	
Work Temperature Range	-20°C to +50°C (When the environment temperature exceeds 30°C, the actual output power is reduced appropriately)	
Storage Temperature Range	-25°C to +60°C	
Enclosure	IP20	
Relative Humidity	< 95% (N.C.)	
Altitude	<4000M (If the altitude exceeds 2000 meters, the actual output power is reduced appropriately)	
Mechanical parameters		
Dimension (Length x Width x Height)	629mm x 291.4mm x 163mm	654mm x 291.4mm x 163mm
Mounting size (Length x Width)	592mm x 200mm	617mm x 200mm
Mounting hole size	Φ9mm/Φ10mm	Φ9mm/Φ10mm
Net Weight	13.3 Kg	15.3 Kg

Model	HP3542-AH0650P20A	HP5542-AH1050P20A
Utility input		
Utility Voltage	176VAC to 264VAC (Default) 90VAC to 280VAC (Configurable)	
Utility Frequency	45Hz to 65Hz	
Maximum Utility Charging Current	60A	100A
Switch Response Time	Switch Response Time – Inverter to Utility: 10ms Switch Response Time – Utility to Inverter (when the load power is higher than 100W): 20ms	
Inverter output		
Inverter Rated Power (@30°C)	3500W	5500W
3-second Transient Surge Output Power	7000W	8500W
Inverter Output Voltage	220/230VAC±3%	
Inverter Frequency	50/60Hz±0.2%	
Output Voltage Waveform	Pure sine wave	
Load Power Factor	0.2 – 1 (VA ≤ Rated output power)	
THDu (Total Harmonic Voltage Distortion)	≤3% (48V resistive load)	

Maximum Load Efficiency	92%	92%
Maximum Inverter Efficiency	94%	94%
Parallel Function	Yes, 12 units in standard, 16 units at most	
Solar controller		
PV Maximum Open-circuit Voltage	500V (At minimum operating environment temperature) 440V (At 25°C)	
MPPT Voltage Range	85V to 400V	
PV Maximum Input Power	4000W	6000W
MPPT Input Channels	One way	Two ways
PV Maximum Input Current	One way, 13A	Two ways, 2x15A
PV Maximum Short-circuit Current	One way, 15A	Two ways, 2x18A
PV Maximum Charging Current	60A	100A
MPPT Maximum efficiency	≥99.5%	
Battery		
Battery Rated Voltage	48VDC	
Battery Work Voltage Range	43.2VDC to 60.0VDC	
Battery Maximum Charging Current	60A	100A
Others		
No-load Losses	<0.8A	<1.1 A
	Test condition: Utility, PV and Load are not connected, AC output is ON, fan stops, @48V input	
Standby Current	<0.6A	<0.75A
	Test condition: Utility, PV and Load are not connected, AC output is OFF, fan stops, @48V input	
Work Temperature Range	-20°C to +50°C (When the environment temperature exceeds 30°C, the actual output power is reduced appropriately)	
Storage Temperature Range	-25°C to +60°C	
Enclosure	IP20	
Relative Humidity	< 95% (N.C.)	
Altitude	<4000M (If the altitude exceeds 2000 meters, the actual output power is reduced appropriately)	
Mechanical parameters		
Dimension (Length x Width x Height)	629mm × 291.4mm × 163mm	679mm × 291.4mm × 163mm
Mounting size (Length x Width)	592mm x 200mm	642mm x 200mm
Mounting hole size	Φ9mm/Φ10mm	Φ9mm/Φ10mm
Net Weight	14.3Kg	17.5Kg

Any changes without prior notice!

Version number: V1.0

HUIZHOU EPEVER TECHNOLOGY CO., LTD.

Tel: +86-752-3889706

E-mail: info@epever.com

Website: www.epever.com