



# LiFePO4 (LFP) Battery

---

## Product manual



**LFP5.42KWH51.2V-P65F1QT50**

# Contents

<b>1 Important Safety Instructions .....</b>	<b>1</b>
<b>2 General Information .....</b>	<b>3</b>
2.1 Appearance .....	3
2.2 Product size .....	4
<b>3 Basic Information .....</b>	<b>5</b>
3.1 Interface definition .....	5
3.2 Product features .....	6
3.3 LED Indicator .....	7
<b>4 Instructions .....</b>	<b>8</b>
4.1 Packing list .....	8
4.2 Installation requirements .....	9
4.3 Charging operation .....	15
4.4 Discharge operation .....	15
4.5 Description of battery parallel capacity and voltage .....	16
<b>5 Protection Features .....</b>	<b>17</b>
<b>6 Specifications .....</b>	<b>22</b>
<b>7 Precautions .....</b>	<b>23</b>
7.1 Maintenance precautions .....	23
<b>8 Disclaimers .....</b>	<b>24</b>

# 1 Important Safety Instructions

※ Thank you for choosing EPEVER Lithium Iron Phosphate (LFP) battery, please read this manual carefully before using this product.

※ It is strictly forbidden to install this product in harsh environments such as moisture, salt spray, corrosion, greasy, flammable and explosive, or a large amount of dust accumulation.

※ Please keep this product manual for future reference.



## Precautions for work and storage

- a) Please keep the battery in a cool, dry place. The environment should be free of corrosive, explosive and insulation-damaging gases or conductive dust, and away from fire and heat sources and high pressure; It is forbidden to immerse the battery in water; Keep out of reach of children; Pay attention to anti-static electricity (static electricity may damage the battery protection circuit, causing battery damage).
- b) The battery should be safely fixed in a reasonable use of the environment, the connector must be reliably connected to avoid contact friction caused by arc and sparks.
- c) When handling the battery, please handle it gently to avoid mechanical vibration, collision and pressure shock. Otherwise, it may cause internal short circuit of the battery, resulting in high temperature and fire.
- d) Do not short-circuit the positive and negative poles of the battery, and do not disassemble or assemble the battery to avoid danger.
- e) Please keep the battery in a semi-charged state (40%~80% SOC is appropriate). Please wrap the battery with non-conductive materials to avoid direct metal contact with the battery, which may cause battery damage.
- f) Please dispose of waste batteries safely and properly, and do not put them into fire or liquid.
- g) This battery cannot be used in series.



## Danger warning

- a) It is strictly forbidden to crush, drop, collide, puncture, burn and other destructive behaviors on the battery.
- b) It is forbidden to disassemble and assemble the battery. Improper disassembly and assembly may damage the protective function of the battery, resulting in deformation, heating, smoke or combustion of the battery.
- c) It is forbidden to short circuit the battery. It is prohibited to connect the positive and negative electrodes of the battery with conductive materials; Do not store or transport the battery with the conductor to avoid battery damage due to short circuit

d) It is forbidden to heat and incinerate batteries. It may melt battery components, lose safety features, or burn electrolyte. Overheating can deform, heat, smoke, or burn the battery.



**Emergency treatment method**

- a) When the electrolyte leaks, avoid skin and eye contact with the electrolyte. In case of contact, wash immediately with plenty of water and seek help from a doctor. It is forbidden for any person or animal to swallow any part of the battery or the substances contained in the battery.
- b) b) If the battery is seriously deformed or the electrolyte leaks due to collision and extrusion, the battery should be placed in the explosion-proof box or an open place, and the personnel should be evacuated quickly if conditions permit,.
- c) If the battery catches fire during use or storage, use a high-pressure water cannon to extinguish the fire under the condition of ensuring personal safety.
- d) d) If the battery catches fire during charging, be sure to turn off the charger as soon as possible before executing the next fire extinguishing action.

## 2 General Information

### 2.1 Appearance

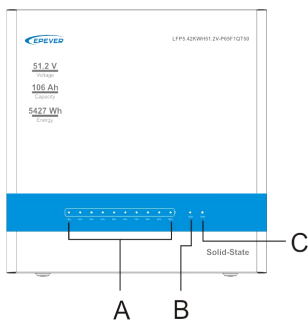

Front

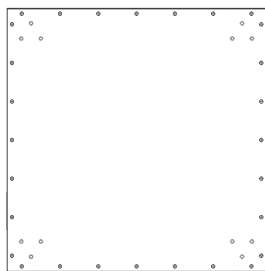

Black

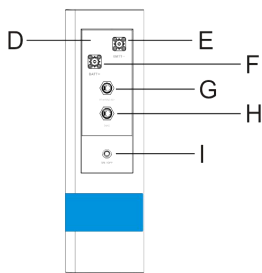

Side

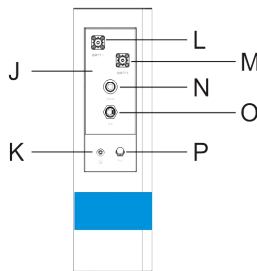

Side

A	Battery SOC indicator	H	Parallel communication interface
B	Malfunction indicator	I	Weak-current switch
C	Running indicator	K	Grounding screw interface
D&J	Metal handle	N	PC upper computer communication interface
E&L	Negative connector	O	Parallel communication interface
F&M	Positive connector	P	Pressure reducing valve
G	Inverter communication interface		

## 2.2 Product size

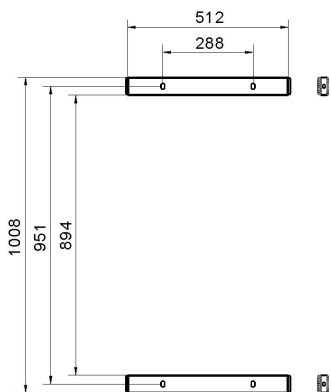
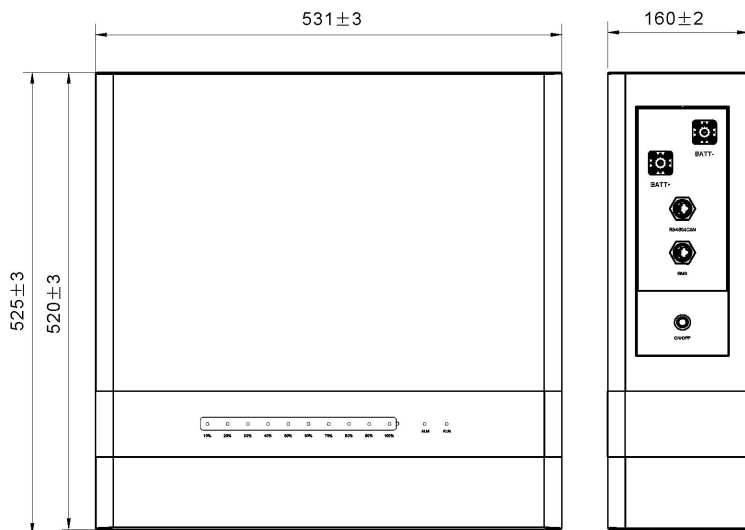

Installation dimensions of fastener strips

### 3 Basic Information

#### 3.1 Interface definition

(1) The RS232 communication interface pin are defined as follows, and the RJ11 communication interface is used to connect the upper computer of the lithium battery PC.

RJ11 Pin	RJ11 Definition
1、 2、 6	NC
3	TX
4	RX
5	GND

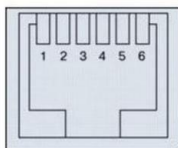

(RJ11)

(2) The pins of the CAN/RS485 communication interface are defined as follows, and the RJ45 communication interface is used for the communication connection between the lithium battery and the inverter host.

Pin No	RJ45 Definition
1	RS485-B
2	RS485-A
3	GND
4	CAN-H
5	CAN-L
6	NC
7	RS485-A
8	RS485-B

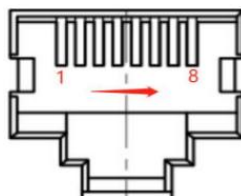

(RJ45 )

(3) The DIP communication interface pin is defined as follows: RJ45 communication interface is used for parallel communication between lithium battery and lithium battery parallel machine.

Pin No	RJ45 Definition
1	RS485-B
2	RS485-A
3	GND
4	GND
5	OP+
6	NC
7	RS485-A
8	RS485-B

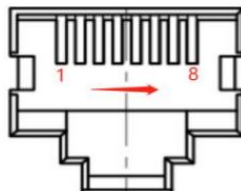

(RJ45 )

(4) The BMS communication interface pins are defined as follows, and the RJ45 communication interface is used for the communication connection between lithium battery and lithium battery parallel machine.

Pin No	RJ45 Definition
1	RS485-B
2	RS485-A
3	GND
4	GND
5	UP-IN
6	NC
7	RS485-A
8	RS485-B

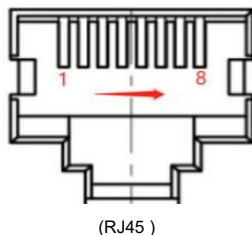

### 3.2 Product features

- It has the function of single voltage and overall voltage detection, over-voltage and under-voltage alarm and protection
- It has the functions of charge and discharge current detection, alarm and protection
- It has the function of cell, environment and PCB temperature detection, and can alarm and protect when charging and discharging at high and low temperature
- It has the function of detection and protection of output short circuit
- With the battery SOC calculation, charge and discharge cycle calculation function
- With a charge balancing function, reduce the charging current of the high-voltage cell (the reduced current is the balance current set by the BMS)
- With LED indicator function, indicating the current battery SOC, battery fault status, operating status, etc
- BMS manual and automatic sleep function
- With charge current limiting function
- With history storage function (not less than 500 storage capacity)
- With RS485 communication function, real-time monitoring of BMS and battery status
- The two-stage over-current protection function of discharge has different response speed to different current values, which protects the battery more reliably.



### 3.3 LED Indicator

① The L1 to L10 of the LED indicator corresponds to the position where the SOC of the battery is 0% to 100%, as shown in the following diagram:













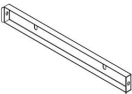
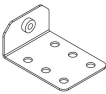
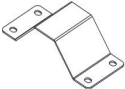

② A total of 12 LED lights on the light board, each light can display red, yellow, blue, green and other colors. It is divided into 3 categories according to the use of the light:

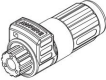
Light	State	Description
Run-led	Normal state	Green light : on solid
	Charging state	Green light : flashing(1Hz)
	Discharge state	Green light : flashing(1Hz)
Alarm-led	Normal state	No alarm or no protection status: off
	Alarm state	Yellow light : flashing (Over-voltage and under-voltage do not make alarm indications, and do not flash yellow lights)
	Protection state	Red light : flashing
	Invalid/failure state	Red light : on solid
Power indicator light	Charging state	Blue light: indicates the power level
	Discharge state	Green light: battery status (low battery) flashing. Flashing frequency: 2 times/second;
Power on self test	Normal state	The self-test status of led (red, blue, green) is as follows: <ul style="list-style-type: none"> <li>◇ Red running light: The red display increases sequentially from the battery indicator Led-01. After the LED light is fully on, it will be completely turned off and enter the next round;</li> <li>◇ Blue running light: The blue display increases sequentially from the battery indicator Led-01. After the LED light is fully on, it will be completely turned off and enter the next round;</li> <li>◇ Green running light: The green display increases sequentially from the battery indicator Led-01. After the LED light is fully on, it will be completely turned off and enter the next round;</li> </ul>
Dormancy		All LED lights: off

## 4 Instructions

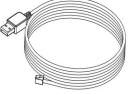
### 4.1 Packing list

Before unpacking, please check the outside of the battery for damage to the packaging and check the model of the battery. If there is any abnormality, please do not open the package and contact the after-sales service center as soon as possible. After unpacking the battery, please check whether the product is complete according to the packaging information. If you have any questions, please contact the after-sales service center as soon as possible.

 X1 Lithium battery	 X1 Fasteners strips for installation against a wall	 X2 Fasteners pieces for installation against a wall
 X1 Connecting plate	 X1 Positive output power cable	 X1 Negative output power cable
 X1 Positive connector quick plug	 X1 Negative connector quick plug	 X2 RNB22-8 wiring terminal
 X1 Battery pack parallel communication cable	 X1 RS485 communication cable	 X1 USB-A to RS232 communication cable
 X2 M8 x 12 bolt group	 X17 M6 x 14 bolt group	 X2 M8 x 60 expansion bolt

## 4.2 Installation requirements

### a. Space installation distance

Master and check the performance of all tools and devices to ensure safety before using them. The left and right distance between battery packs is recommended. Minimize the distance as much as possible.

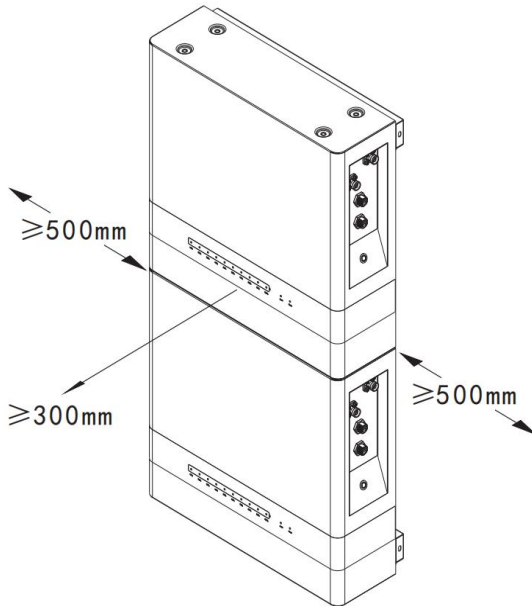

### b. Installation environment

- The battery works best at 20~40°C.
- Avoid installation in environments with direct high temperature and rain.
- Avoid installation close to high temperature heat source or low temperature cold source.
- Avoid installation in places where the ambient temperature changes drastically.
- Avoid installation in strong interference environments.
- Avoid installation in places where children can enter.
- Avoid installation in places where water is likely to accumulate.
- It is forbidden to place flammable and explosive materials around the equipment.

### c. Prepare tools

				
Hammer Drill	Rubber Hammer	Claw Safety Hammer	Insulated Cross Screwdriver	Insulated Slotted Screwdriver
				
Spirit Level	Tape Ruler	Insulation Tape	Dustproof Cover	Protective Glasses
				
Utility Knife	Wire Stripper	Diagonal Pliers	MC4 Crimper	Multimeter
				
AC/DC Clamp-On Ammeter	Marker Pen	Electric Screwdriver		

#### d. Space installation requirements

1. Make the mounting bracket close to the wall (level correction), mark the screw holes with a marker, and then remove the mounting bracket.

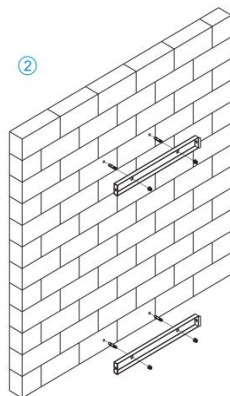
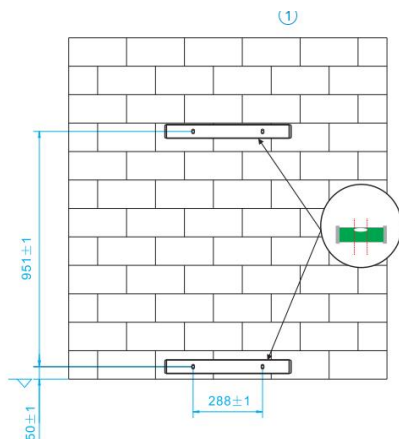

2. Use a hammer drill to drill a hole in the wall (diameter: 10mm, depth: 65mm), insert the M8 expansion screw and tighten it.

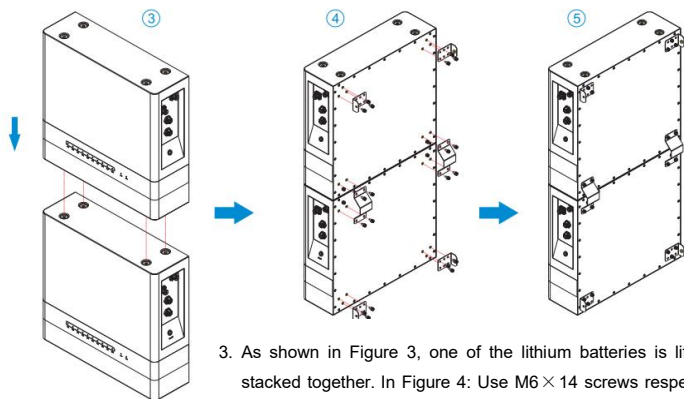

3. As shown in Figure 3, one of the lithium batteries is lifted vertically and stacked together. In Figure 4: Use M6  $\times$  14 screws respectively to lock the fasteners pieces 1/fasteners pieces 2, the connecting piece and other accessories. And the effect is shown in Fig. 5.

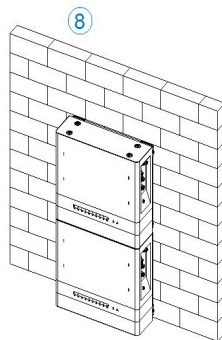
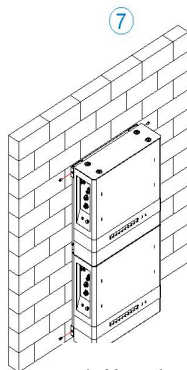
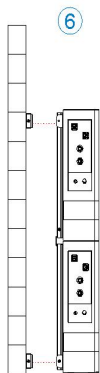

4. Move the stacked and fixed lithium battery packs to the position shown in Figure 6. Align the fasteners strips against the wall, move them horizontally, and affix the fasteners strips.

As shown in Figure 7, use four M6X14 screws to lock the lithium battery pack from both sides. The final completion is shown in Figure 8.

### e. Wiring diagram

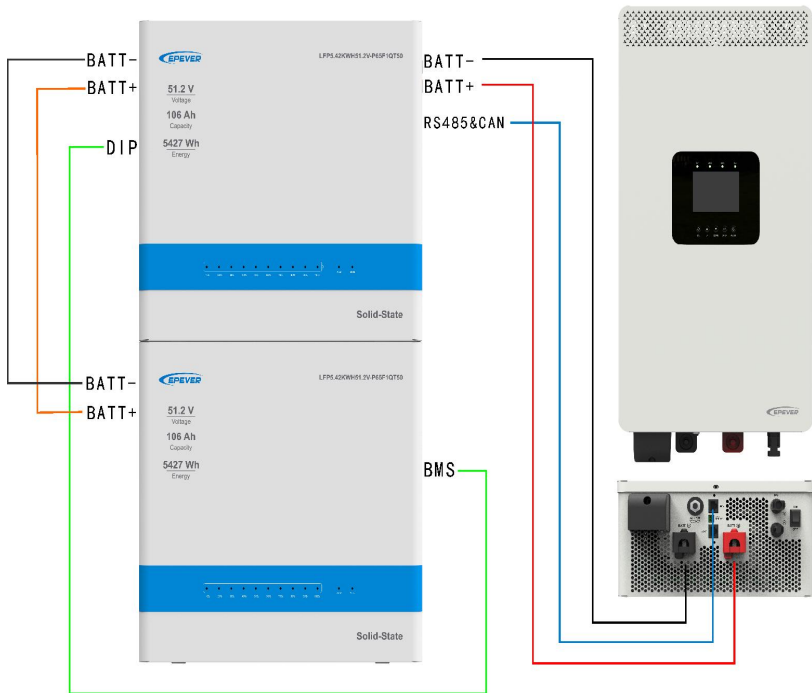

- Positive output power cable (1500mm)
- Negative output power cable (1500mm)
- RS485 communication cable (1500mm)
- Lithium battery positive parallel power cable
- Lithium battery negative parallel power cable
- Lithium battery parallel communication cable(DIP-BMS)(1200mm)

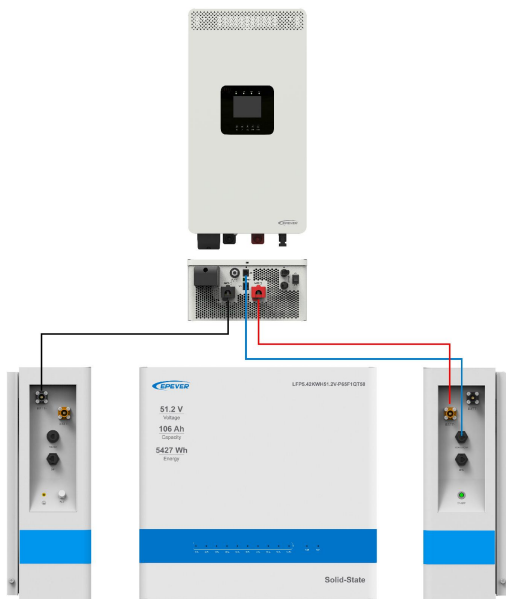

- Positive output power cable (1500mm)
- Negative output power cable (1500mm)
- RS485 communication cable (1500mm)



## Warning

1. For operational safety and compliance, please disconnect the communication and cable link with the inverter when storing the battery.
2. During the handling and installation of the battery, it is recommended to wear safety helmets, goggles, protective shoes and other safety equipment suitable for the work to prevent accidental injury;
3. All wiring must be carried out by professionals. With the right cables, the battery connection is essential for the safe and efficient operation of the system. In order to reduce the risk, please use the cable provided by our company, or our recommended cable specifications.



## 4.3 Charging operation

### 1. Check before charging.

- Inspect the appearance of the battery and inverter or other connected equipment to ensure that the power cord and all wiring harnesses are connected.
- Make sure the power supply meets the specification requirements for the battery.

### 2. Turn off the inverter or other equipment, connect the positive and negative terminals of the battery, and connect the communication cable normally.

 **Warning: Before connecting the battery, ensure that the positive and negative terminals are connected. Do not reverse connect.**

### 3. Connect the charger to the power supply and turn on the charger.

### 4. Start the battery, the POWER indicator is on, and the SOC indicator flashes to start charging normally.

#### ● **Standard Charging:**

First, charge the battery to 57.6V with a constant current of 20A (0.2C), and then charge to 5A (0.05C) with a constant voltage of 57.6V.

**Note: All tests stated in this document shall be performed at 25±2°C.**

## 4.4 Discharge operation

### 1. Before discharging, check whether the load and equipment are turned off.

### 2. Properly connect the positive and negative terminals of the battery to the load/inverter or other equipment.

 **Warning: Before connecting the load and equipment, please confirm the positive and negative wiring of the battery, and prohibit reverse connection.**

### 3. Turn on the load/inverter or other device.

### 4. Start the battery. The POWER indicator is steady on, the RUN indicator is on for 0.5 seconds, and the discharge starts for 1.5 seconds.

#### **Standard discharge:**

After the battery is standard charged, discharging the battery with a constant current of 20A (0.2C) till the battery voltage drops to 41.6V.

**Note: All tests stated in this document shall be performed at 25±2°C.**

#### **Precautions for charging and discharging operation:**

- a) When the temperature is high ( $\geq 35^{\circ}\text{C}$ ) in summer, the battery should not be charged more than 0.5C during the day, and it is recommended to stand for more than 30 minutes in the middle of the charge-discharge conversion to avoid the battery being used often in a high-temperature environment (a high-temperature environment will affect the battery life).
- b) When the temperature is low ( $< 0^{\circ}\text{C}$ ) in winter, the depth of battery discharge  $< 70\%$  to avoid over-discharge of the battery caused by too low temperature and affect the battery life.

 **Warning: This lithium battery should only be used with a manufacturer or manufacturer-matched compatible inverter or other equipment. When the lithium battery does not communicate with the inverter or other equipment, it is forbidden to use the lithium battery.**

#### 4.5 Description of battery parallel capacity and voltage

Capacity	Number of battery parallel groups	Maximum charging voltage	Discharge cut-off voltage
212Ah	2 groups	57.6V	41.6V
318Ah	3 groups	57.6V	41.6V
424Ah	4 groups	57.6V	41.6V
530AH	5 groups	57.6V	41.6V
636Ah	6 groups	57.6V	41.6V
742Ah	7 groups	57.6V	41.6V
848Ah	8 groups	57.6V	41.6V

## 5 Protection Features

No	Item	Factory default parameter	Set state	Postscript
1	Cell overcharge protection	Cell overcharge alarm voltage	3600mV	settable
		Cell overcharge protection voltage	3650mV	settable
		Cell overcharge protection delay	1.0S	settable
	Cell over-voltage protection release	Cell overcharge protection voltage	3380mV	settable
		SOC release	SOC<96%	settable
		Discharge release	Discharge current>2A	
2	Cell over-discharge protection	Cell over-discharge alarm voltage	3380mV	settable
		Cell over-discharge protection voltage	3380mV	settable
		Cell over-discharge protection delay	1.0S	settable
	Cell over-discharge release	Cell over-discharge protection release voltage	2950mV	settable
		Release on charge	Plug in the charger to activate	
3	Battery overcharge protection	Battery overcharge alarm voltage	57.6V	settable
		Battery overcharge protection voltage	58.4V	settable
		Battery overcharge protection delay	1.0S	settable
	Battery overcharge protection release	Battery overcharge protection release voltage	54V	settable
		SOC release	SOC<96%	settable
		Discharge release	Discharge current>2A	

4	Overall over-discharge protection	Battery over-discharge alarm voltage	44.8V	settable	
		Battery over-discharge protection voltage	43.2V	settable	
		Battery over-discharge protection voltage delay	1.0S	settable	
	Battery over-discharge protection release	Battery over-discharge protection release voltage	47.2V	settable	
		Release on charge	Plug in the charger to activate		
5	Charge over-current protection	Charging over-current alarm current	105A	settable	If the status is locked for 10 consecutive times, it cannot be automatically unlocked
		Charging over-current protects the current	110A	settable	
		Charging over-current protection delay	1.0S	settable	
	Charge over-current protection release	Automatic release	Automatically disconnects after 1mins		
		Discharge release	Discharge current > 1A		
6	Discharge over-current 1 protection	Discharge over-current 1 alarm current	105A	settable	Appearing 10 times in a row will lock the state and will no longer be automatically disconnect
		Discharge over-current 1 Protects current	110A	settable	

		Discharge over-current 1 Protection delay	1.0S	settable	
	Discharge over-current 1 protection release	Automatic disconnect	Automatically disconnects after 1 minute		
7	Discharge over-current 2	Protection current	> 150A	settable	It can be set 10 consecutive occurrences to lock the state without automatically disconnecting
		Protection delay	500mS	settable	
	Discharge over-current 2 protection release	Automatic disconnect	Automatically disconnects after 1 minute		
		Charge disconnect	Discharge current > 1A		
8	Short circuit protection	Short-circuit protection function	Available		
		Short-circuit release	When there is charging, the short circuit protection is removed		
			After the load is removed, it is automatically removed		
9	MOS high temperature protection	Alarm temperature	90° C	settable	
		Protective temperature	115° C	settable	
		Release temperature	85° C	settable	
10	Cell temperature protection	Charge low temperature alarm	5°C	settable	
		Charge low temperature protection	0°C	settable	
		Charge low temperature protection release	5°C	settable	

		Charging high temperature alarm	60°C	settable	
		Charging high temperature protection	65°C	settable	
		Charge high temperature protection release	55°C	settable	
		Discharge low temperature alarm	-15°C	settable	
		Low temperature discharge protection	-20°C	settable	
		Discharge low temperature protection release	-15°C	settable	
		High discharge temperature alarm	65°C	settable	
		Discharge high temperature protection	70°C	settable	
		Discharge high temperature protection release	60°C	settable	
		11	Ambient temperature alarm	Ambient low temperature alarm	
Ambient low temperature protection	-20°C			settable	
Environmental low temperature protection release	-15°C			settable	
Ambient high temperature alarm	65°C			settable	

		Ambient high temperature protection	75°C	settable	
		Ambient high temperature protection release	65°C	settable	
12	Low battery alarm	Low battery alarm condition	SOC<5%	settable	No alarm when charging
13	Sleep function	Sleep voltage	3150mV	settable	
		Delay time	5min	settable	
		Cell voltage difference	voltage difference>1V	settable	Charging and discharging are not allowed
14	Full charge	Full charge voltage	>56V	settable	When both conditions are met, stop charging and update the SOC to 100%
		Cut-off current	<2A	settable	

(Note: Unless otherwise specified, the above parameters are tested at 25°C ambient temperature.)

## 6 Specifications

Parameter	LFP5.42KWH51.2V-P65F1QT50
Battery Type	LiFePO <sub>4</sub>
Nominal Voltage	51.2V
Nominal Capacity	106Ah
Energy	5427Wh
Continuous Discharge Current	50A
Charge Cut-off Voltage	57.6V
Discharge Cut-off Voltage	41.6V
Maximum Charge Current	50A
Maximum Discharge Current	100A@30min
Peak Discharge Current	120A@10S
Recommend Discharge Current	50A
Open-circuit Voltage	50.88~53.6V
Communication	RS485 RS232 CAN
Display	LED
Cycle Life	>5000 times (0.5C charge&discharge 80%DOD @25°C)
Number of series/parallel	Max 8 battery packs in parallel
Certification	UN38.3 MSDS IEC62619 ROHS
Charge&Discharge Temperature	Charge: 0°C~+55°C Discharge: -20°C~+55°C
Storage Temperature Range	-5°C~+0°C/35°C~+45°C (≤2month); 5°C~+35°C (≤3 months, Optimum storage temperature); 15°C~+35°C (≤6 months)
Relative Humidity	60%±20% RH
Connect Terminal	Quick-plug
Dimension (L x W x H)	531mm x 160mm x 525mm
Net Weight	48.7±0.5kg
IP Class	IP65
Warranty	3 years (See warranty agreement for details)

① Repeat the operation method of standard charging and standard discharge 3 times, and take the third result as the initial capacity of the battery.

② When the battery is stored for more than 3 months, the storage voltage should be maintained at 52~53.6V

③ For long-term storage, charge at least once every 3 months (no less than 30 minutes@0.2C).



## 7 Precautions

### 7.1 Maintenance precautions

Item	Cycle
If the battery is not in use, it needs to be fully charged and discharged to 50%.	3 months
Check whether the wall bracket installation is loose. Please tighten the appropriate position if available.	6 months
Check the casing for damage. If damaged, please repaint or contact after-sales service center.	6 months
Check exposed wires for wear and tear. If the cable is worn, replace the appropriate cable or contact the service center.	6 months
Check for debris buildup around the battery. Clean it to prevent heat dissipation of the battery.	6 months
Check water or pests to avoid long-term intrusion and damage to the battery.	6 months



#### Warning

1. If you find any problems that may affect the battery or the battery and energy storage system, please contact the after-sales service department, disassembly is strictly prohibited.
2. If you find that the copper wire inside the conductive wire is exposed, please strictly prohibit touching it due to the danger of high voltage. Please contact the after-sales personnel, disassembly is strictly prohibited.
3. If there are other emergencies, please contact the after-sales personnel first, operate under the guidance of the after-sales personnel, or wait for the after-sales personnel to operate on site.

## 8 Disclaimers

**The warranty does not apply to the following conditions:**

- Damage caused by improper use or inappropriate environments (It is strictly forbidden to install the Energy Storage System in the humid, salt spray, corrosive, greasy, flammable, explosive, dust accumulative or other harsh environments).
- The actual current/voltage/power exceeds the limit value of the Energy Storage System.
- Damage caused by working temperature exceeding the rated temperature range.
- Electric arc, fire, explosion and other accidents caused by failure to follow the Energy Storage System labels or manual instructions.
- Unauthorized disassembly and maintenance of the Energy Storage System.
- Damage caused by force majeure such as lightning strikes, rainstorms, mountain torrents and Utility failures.
- Damage occurred during transportation or loading/unloading the Energy Storage System.

**Any changes without prior notice! Version number: V1.0**

**HUIZHOU EPEVER TECHNOLOGY CO., LTD**

**BeiJing Service Hotline: 010-82894896/82894112**

**Huizhou Service Hotline: 0752-3889706**

**Shenzhen Service Hotline: 0755-89236770**

**E-mail: [sales@epever.com](mailto:sales@epever.com)**

**Website: [www.epever.com.cn](http://www.epever.com.cn)**