



LiFePO4 (LFP) Battery

User Manual



LFP10.5KWH51.2V-P20R2GF30

Contents

1 Important Safety Instructions	1
2 General Information	3
2.1 Appearance	3
2.2 Features	5
2.3 LED Indicators	6
2.4 Set the DIP Switch	9
3 Operation Instruction	10
3.1 Charging Operation	10
3.2 Discharging Operation	10
3.3 Battery Connection in Parallel	11
4 Protections	12
5 Specifications	14
6 Dimensions	15
7 Disclaimers	16

1 Important Safety Instructions

※ Thanks for selecting the EPEVER LiFePO4 battery; please read this manual carefully before using the product.

※ Do not use the product in humid, salt spray, corrosion, greasy, flammable, explosive, dust accumulative, or other severe environments.

※ Please keep this manual for future reference.



Work and storage precautions:

- a) Please store the battery in a cool and dry place. Keep the battery away from corrosive, explosive, and insulating gases or conductive dust, as well as from sources of fire, heat, and high voltage. It is forbidden to immerse the battery in water, and keep children out of reach of the battery. No static electricity to the battery (static electricity can easily damage the battery protection circuit and cause battery damage).
- b) Fix the battery securely in a reasonable environment, and connect the connector reliably to avoid contact friction causing arcs and sparks.
- c) Handle the battery gently to avoid mechanical vibration, collision and pressure shock. Otherwise, it may cause the battery short circuit, resulting in high temperature and fire.
- d) Do not short-circuit the battery, and do not disassemble the battery to avoid danger.
- e) Please keep the battery in a half-charge state (40%~80% SOC is preferred). Please use non-conductive materials to wrap the battery, to avoid direct contact between metal and the battery, which may cause damage to the battery.
- f) Dispose of discarded batteries safely and do not put them in fire or liquid.
- g) This battery cannot be connected in series.



Hazard Warning

- a) It is strictly forbidden to crush, drop, collide, puncture, burn and other destructive acts on the battery.
- b) Do not disassemble the battery. Improper disassembly may damage the battery's protection function, causing battery deformation, heating, smoking, or burning.
- c) Do not short-circuit the battery. It is prohibited to connect the battery positive and negative poles with conductive materials. And store and transport the battery together with conductive materials is also prohibited.
- d) Do not heat or burn batteries. Otherwise, it will cause the melting of battery components, loss of safety functions, or electrolyte combustion. Overheating can deform the battery, heat up, smoke or burn.



Emergency treatments

- a) Avoid skin and eye contact with the electrolyte when it leaks. In case of contact, immediately wash with plenty of water and seek help from a doctor. It is forbidden for any person or animal to swallow any part of the battery or the substances contained in the battery.
- b) If the battery is severely deformed or electrolyte leakage occurs, the battery should be placed in an explosion-proof box or open space when conditions permit; and personnel should evacuate quickly.
- c) If the battery catches fire during use or storage, use a high-pressure water gun to extinguish the fire while ensuring personal safety.
- d) If the battery catches fire during the charging process, turn off the charger power first and then take the next step to extinguish the fire.

2 General Information

2.1 Appearance

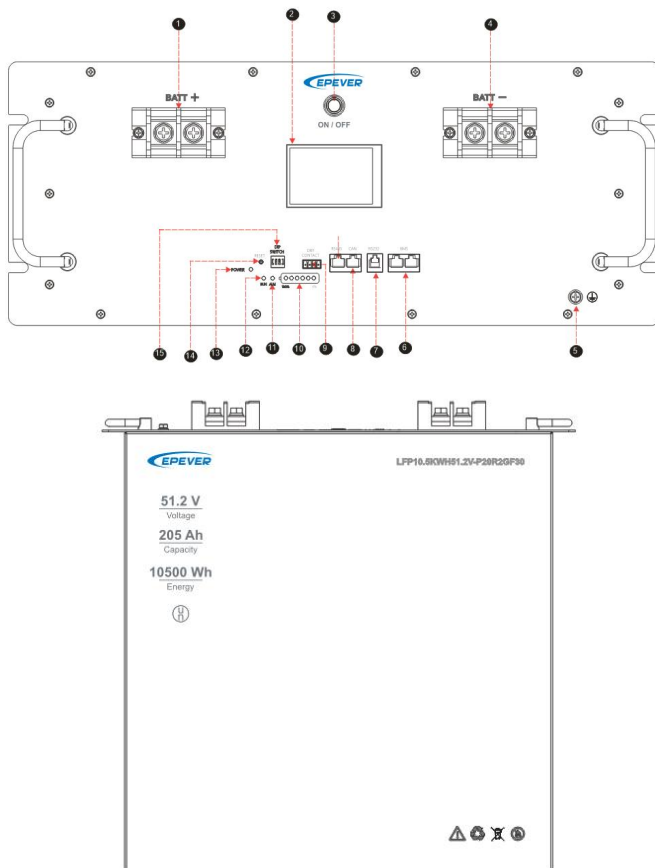

No.	Instruction	No.	Instruction
①	Battery positive terminal	⑨	Dry contact interface
②	LCD Display	⑩	Battery SOC indicator
③	Power switch	⑪	ALARM indicator
④	Battery negative terminal	⑫	RUN indicator
⑤	Grounding screw	⑬	POWER indicator
⑥	BMS com. port	⑭	Reset button
⑦	RS232com. port	⑮	DIP switch
⑧	RS485com. port		

- (1) The DIP switch is used to set the communication address of the battery when the battery is connected in parallel.
- (2) When the BMS is in standby or working state, press and hold the RESET button for 6 seconds, and the BMS will be reset and the battery will be restarted.
- (3) For instructions of the POWER/RUN/ALARM indicators and the battery SOC indicators, refer to section "2.3 LED Indicators."
- (4) The RS485 communication port (RJ45) is used to connect the EPEVER inverter. The RS232 communication port (RJ11) is used to connect to the PC software for modifying battery parameters, upgrading BMS software, etc. Pin definition for RJ45 and RJ11:
 - The RS232 communication interface pin is defined as follows, and the RJ11 communication interface is used to connect the upper computer of the lithium battery PC.

RJ11 pin	RJ11 definition
1、2、6	NC
3	TX
4	RX
5	GND

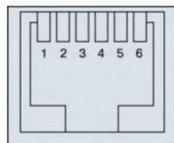

(RJ11)

- The CAN/RS485 communication pin is defined as follows. The RJ45 communication port is used to connect the lithium battery to the inverter host.

Pin	RJ45 definition	Pin	RJ45 definition
1	RS485-B	5	CAN-L
2	RS485-A	6	NC
3	GND	7	RS485-A
4	CAN-H	8	RS485-B

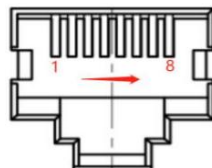

(RJ45)

(5) The BMS communication ports (dual-RJ45 port) is used to connect the battery in parallel.

2.2 Features

- Equipped with detection of cell voltage and overall voltage, alarm and protection for the over-voltage and under-voltage.
- Equipped with detection, alarm and protection for the charge and discharge current.
- Equipped with temperature detection for the cell, environment, and PCB; alarm and protect when charging and discharging at high and low temperatures.
- Equipped with detection and protection for the output short-circuit.
- Equipped with SOC calculation and charge discharge cycles calculation.
- Equipped with charging equalization function, reducing the charging current of high-voltage cells (the reduced current is the equalize current set by BMS).
- Equipped with LED indicators, indicating the battery SOC, fault status, running status, etc.
- Equipped with BMS manual and automatic sleep functions
- Auto charging current limit function.
- History storage function (not less than 500 storage capacity).
- With RS485 communication function to monitor the BMS and battery in real time.
- Two-level over-current protection for discharge, with different response speeds for different current, providing more reliable protection for the battery.

2.3 LED Indicators

● Battery Work Indicators instructions

Status	Normal/Alarm/Protection	POWER ●	RUN ●	ALM ●	Battery SOC LED ^①						Instruction
					L6 ●	L5 ●	L4 ●	L3 ●	L2 ●	L1 ●	
					Power off	Sleep ^②	OFF	OFF	OFF	OFF	
Standby	Normal	ON	Flash 1★	OFF	Display by the actual battery capacity.						Standby Status
	Alarms	ON	Flash 1★	Flash 3★							Module low voltage
Charging	Normal	ON	ON	OFF	Display by the actual battery capacity. (Note: When fully charged, the light marked 100% will light up for 0.5 seconds and then turn off for 0.5 seconds.)						The indicator flashes according to the battery capacity, and the ALM indicator does not flash during overcharge alarm.
	Alarms	ON	ON	Flash 3★							
	Over-charge Protection	ON	ON	OFF	ON	ON	ON	ON	ON	ON	If there is no Utility power supply, the indicator will enter the standby mode.
	Temperature, over-current, and failure protections	ON	OFF	ON	OFF	OFF	OFF	OFF	OFF	OFF	OFF

Status	Normal/Alarm/Protection	POWER	RUN	ALM	Battery SOC LED ^①						Instruction
		●	●	●	L6	L5	L4	L3	L2	L1	
		●	●	●	●	●	●	●	●	●	
Discharging	Normal	ON	Flash 3★	OFF	Display by the actual battery capacity.						--
	Alarms	ON	Flash 3★	Flash 3★							
	Under-voltage protection	ON	OFF	OFF	OFF	OFF	OFF	OFF	OFF	OFF	The battery stops discharging.
	Temperature, over-current, short-circuit, reverse connection, and failure protections	ON	OFF	ON	OFF	OFF	OFF	OFF	OFF	OFF	The battery stops discharging.
Failure	--	OFF	OFF	ON	OFF	OFF	OFF	OFF	OFF	OFF	The battery stops charging and discharging.

① The battery SOC indicators L1~L6 correspond to the battery SOC 0%~100%, as shown in the diagram below:



② Exit sleep mode: When the BMS is in sleep mode, press and hold the power switch (ON/OFF button) for about 2 seconds to activate the battery.

Enter sleep mode: When the BMS is in standby or working state, press and hold the power switch for 3 seconds.

★ [Flash 1] means the indicator lights up for 0.25 seconds and then turn off for 3.75 seconds.

[Flash 2] means the indicator lights up for 0.5 seconds and then turn off for 0.5 seconds. [Flash 3] means the indicator lights up for 0.5 seconds and then turn off for 1.5 seconds.

● Battery SOC Indicators (Charging)

Battery Status		Charging					
		L6	L5	L4	L3	L2	L1
Battery SOC Indicators		●	●	●	●	●	●
Battery SOC (%)	0%~17%	OFF	OFF	OFF	OFF	OFF	Flash 2★
	18%~33%	OFF	OFF	OFF	OFF	Flash 2★	ON
	34%~50%	OFF	OFF	OFF	Flash 2★	ON	ON
	51%~66%	OFF	OFF	Flash 2★	ON	ON	ON
	67%~83%	OFF	Flash 2★	ON	ON	ON	ON
	84%~100%	Flash 2★	ON	ON	ON	ON	ON
Run indicator ●		ON					

● Battery SOC Indicators (Discharging)

Battery Status		Discharging					
		L6	L5	L4	L3	L2	L1
Battery SOC Indicators		●	●	●	●	●	●
Battery SOC (%)	0%~17%	OFF	OFF	OFF	OFF	OFF	ON
	18%~33%	OFF	OFF	OFF	OFF	ON	ON
	34%~50%	OFF	OFF	OFF	ON	ON	ON
	51%~66%	OFF	OFF	ON	ON	ON	ON
	67%~83%	OFF	ON	ON	ON	ON	ON

	84%~100%	ON	ON	ON	ON	ON	ON
Run indicator ●	Flash 3★						

★ [Flash 1] means the indicator lights up for 0.25 seconds and then turn off for 3.75 seconds. [Flash 2] means the indicator lights up for 0.5 seconds and then turn off for 0.5 seconds. [Flash 3] means the indicator lights up for 0.5 seconds and then turn off for 1.5 seconds.

2.4 Set the DIP Switch

When the battery pack is used in parallel, the communication address of each battery pack can be set by the DIP switch. The address cannot be set to the same. The definition of the DIP switch is referred to the following table. In battery parallel mode, the lithium battery with the address of 1 is the main battery.

When batteries are not in parallel, the default DIP is 1, and the batteries can communicate with others.

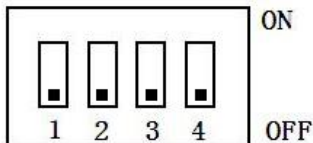

Communication Address	DIP switch location			
	#1	#2	#3	#4
0	OFF	OFF	OFF	OFF
1	ON	OFF	OFF	OFF
2	OFF	ON	OFF	OFF
3	ON	ON	OFF	OFF
4	OFF	OFF	ON	OFF
5	ON	OFF	ON	OFF
6	OFF	ON	ON	OFF
7	ON	ON	ON	OFF
8	OFF	OFF	OFF	ON

3 Operation Instruction

3.1 Charging Operation

1. General Checking.

- Check thoroughly including all the cables for showing no damages.
- Make sure the mains supply complies with the specification of the charger and the battery.

2. Turn off the charger and connect it to the battery.

 **WARNING: Check the battery polarity before connecting to the charger. It is forbidden to reverse connect the battery.**

3. Connect the charger to mains supply and turn on the charger.

4. Press the power switch once, the charging process starts after the POWER and RUN indicators are ON solid.

- **Standard charge:**

First, charge the battery to 57.6V with a constant current of 40A (0.2C), and then charge to 10A (0.05C) with a constant voltage of 57.6V.

Note: All tests stated in this document shall be performed at $25 \pm 2^{\circ}\text{C}$.

3.2 Discharging Operation

1. Before discharging, ensure the load and equipment are in the off state.

2. Connect the battery to the load and equipment correctly.

 **WARNING: Check the battery polarity before connecting to the load and equipment. It is forbidden to reverse connect the battery.**

3. Turn on the load and equipment.

4. Press the power switch once, the discharging process starts after the POWER indicator is ON solid, and the RUN indicator ON 0.5S->OFF 1.5S.

- **Standard discharge:**

After the battery is standard charged, discharging the battery with a constant current of 40A (0.2C) till the battery voltage drops to 41.6V.

Note: All tests stated in this document shall be performed at $25 \pm 2^{\circ}\text{C}$.



Precautions for charging and discharging:

- a) During the summer when temperatures are high ($\geq 35^{\circ}\text{C}$), it is not recommended to use fast charging during the day. If fast charging is needed during the day, it is best to wait at least one hour after discharging and the charging time should not exceed half an hour.

b) During the winter when temperatures are low ($<0^{\circ}\text{C}$), the battery should be charged as soon as possible after discharge to avoid prolonged charging time due to low battery temperature.

⚠ WARNING: This lithium battery can only be used with EPEVER devices or the compatible devices. It is forbidden to use the lithium battery without communicate.

3.3 Battery Connection in Parallel

Battery Capacity	Number of parallel batteries	Maximum Charge Voltage	Discharge Cut-off Voltage
410Ah	2 pcs	57.6V	41.6V
615Ah	3 pcs	57.6V	41.6V
820Ah	4 pcs	57.6V	41.6V
205Ah*n	N = 8 pcs at most	57.6V	41.6V

The schematic diagram of batteries connected in parallel is as follows:

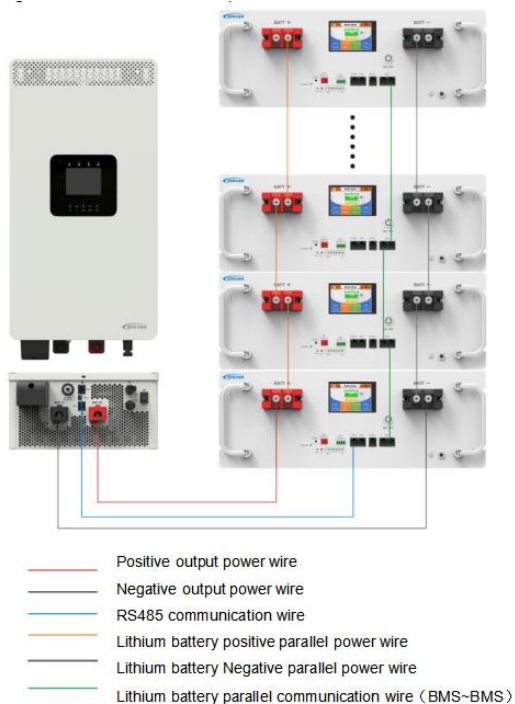

4 Protections

1. Cell/Overall Over-charge Protection

When the actual voltage of any cell/overall is higher than the over-charge protection voltage, and the duration reaches the over-charge delay, the battery enters the over-charge protection state. The charging MOS and charging current limiting module are turned off, and the battery cannot be charged.

Protection Recovery: When the actual voltage of any cell/overall drops below the overcharge recovery voltage, the over-charge protection state is released. Protection can also be released by discharging.

2. Cell/Overall Over-discharge Protection

When the actual voltage of any cell/overall is lower than the over-discharge protection voltage, and the duration reaches the over-discharge delay, the battery enters the over-discharge protection state. The discharging MOS is turned off, and the battery will not discharge.

Protection Recovery: Charge the battery to release the over-discharge protection state.

3. Charge Over-current Protection (no charging current limit function)

When the actual charging current exceeds the charging over-current protection current, and the duration reaches the over-current delay, the battery enters the charging over-current protection state and cannot be charged.

Protection Recovery: After an over-current occurs during charging, the battery will automatically recover after a delay. After 10 consecutive attempts (which can be set), the battery will be locked and no longer recover. Charge over-current protection can also be released by discharging.

4. Discharge Over-current Protection

When the actual discharge current exceeds the over-current protection current, and the duration reaches the over-current delay, the battery enters the discharge over-current protection state. The battery no longer discharges.

Protection Recovery: After an over-current occurs during discharging, the battery will automatically recover after a delay. After 10 consecutive attempts (which can be set), the battery will be locked and no longer recover. Discharge over-current protection can also be released by charging the battery.

5. Charge/Discharge High Temperature Protection

During the charging and discharging process, when the NTC (negative temperature coefficient thermistor) detects that the cell temperature is higher than the high temperature protection value, the charging or discharging MOSFET is turned off. In this state, the battery cannot be charged or discharged.

Protection Recovery: The cell temperature drops to the high temperature recovery value.

6. Charge/Discharge Low Temperature Protection

During the charging and discharging process, when the NTC detects that the cell temperature is lower than the low temperature protection value, the charging or discharging MOSFET is turned off. In this state, the battery cannot be charged or discharged.

Protection Recovery: The cell temperature rises to the low temperature recovery value.

7. Environmental and PCB Temperature Alarm

When the NTC detects that the environmental and PCB temperature have reached the alarm value, the BMS issues a temperature alarm signal.

Protection Recovery: The alarm will be cleared when the temperature drops to the alarm recovery value.

5 Specifications

Model	LFP10.5KWH51.2V-P20R2GF30
Battery Type	LiFePO ₄ (LFP)
Nominal Voltage	51.2V
Nominal Capacity	205Ah
Energy	10500Wh
Continuous Discharge Current	100A
Charge Cut-off Voltage	57.6V
Discharge Cut-off Voltage	41.6V
Maximum Charge Current	150A
Maximum Discharge Current	200A@30min
Peak Discharge Current	240A @10s
Recommend Discharge Current	100A
Work Voltage Range	43.2~57.6V
Communication Method	RS485 CAN RS232
Display	LED
Cycle Life@Normal Temperature	>3000 times (0.5C charge&discharge 80%DOD @25℃)
Number of Series/Parallel	Max 4 battery packs in parallel
Certification	UN38.3 MSDS IEC62619
Work Temperature Range	Charging: 0~+55℃, Discharging: -20~+55℃
Storage Temperature Range	-5℃~+0℃/35℃~+45℃ (≤2month); 5℃~+35℃ (≤3 months, best storage temperature); 15℃ ~+35℃ (≤6 months)
Relative humidity	60± 20% RH
Connection Terminal	Quick-plug
Dimension (Length x Width x Height)	550mm*530mm*232mm
Net Weight	90.1±0.5kg
Enclosure	IP20
Warranty	3 years (see warranty agreement for details)

① Repeat the operation method of standard charging and standard discharge 3 times, and take the third result as the initial capacity of the battery.

② When the battery is stored for more than 3 months, the storage voltage should be maintained at 52~53.6V

③ For long-term storage, charge at least once every 3 months (no less than 30 minutes@0.2C).

6 Dimensions

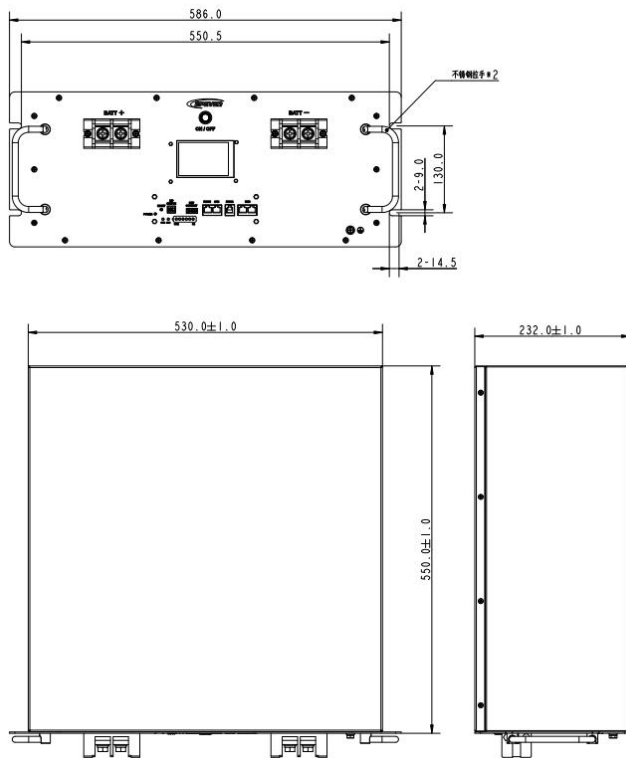

7 Disclaimers

The warranty does not apply to the following conditions:

- Damage caused by improper use or inappropriate environments (It is strictly forbidden to install the Energy Storage System in the humid, salt spray, corrosive, greasy, flammable, explosive, dust accumulative or other harsh environments).
- The actual current/voltage/power exceeds the limit value of the Energy Storage System.
- Damage caused by working temperature exceeding the rated temperature range.
- Electric arc, fire, explosion and other accidents caused by failure to follow the Energy Storage System labels or manual instructions.
- Unauthorized disassembly and maintenance of the Energy Storage System.
- Damage caused by force majeure such as lightning strikes, rainstorms, mountain torrents and Utility failures.
- Damage occurred during transportation or loading/unloading the Energy Storage System.

Any changes without prior notice! Version number: V1.1

HUIZHOU EPEVER TECHNOLOGY CO., LTD.

Tel: +86-752-3889706

E-mail: info@epever.com

Website: www.epever.com